

SENSALARM PLUS

Universal Gas Monitoring System

User Manual

Document No. 360-0126-01
(Revision H)



SENSIDYNE®

Sensidyne, LP
1000 112TH Circle N, Suite 100
St. Petersburg, Florida 33716 USA
800-451-9444 • +1 727-530-3602 • +1 727-539-0550 [fax]
web: www.sensidyne.com • e-mail: info@sensidyne.com

How to Use This Manual

This manual is a basic guide for using the SensAlarm *Plus* Universal Gas Monitoring System. It contains information on SensAlarm *Plus* components, sensor types, and the Normal Operation Display. It also shows how to mount and wire the Monitor, initial setup, zero, and span calibration. In addition, it covers commonly used operations regarding alarms, relays, and Test-On-Demand.

Important notes, cautions, and warnings are set off from the other text as follows:

NOTE

This is an important note

MENU MAP and MENU FUNCTIONS

The entire menu structure is outlined in **Section 5.2, Menu Structure**, with descriptions of each function in **Section 3, Operating Functions** and **Section 4, Alarms and Relays**.

The SensAlarm *Plus* Gas Monitor is menu driven, so is important to become familiar with how the four magnetic switch controls are used to navigate through the menus, select specific menu items, and change the many different parameters available to the user. The Basic Menu Controls Guide is below.

Basic Menu Controls Guide

Selecting OK from the Normal Operation Display enters the SensAlarm *Plus* menu system. Within the menu system OK is to 1) to select an item from a list of menu items, 2) to confirm that an action has occurred (e.g. changing an alarm from “Non-Latching” to “Latching”), or 3) to save a new value that has been entered (e.g., a notation for configured). It is similar in use to an ESC key on a computer keyboard.

The ▲ control arrow is used to move UP a list of menu items.

The ▼ control arrow is used to move DOWN a list of menu items.

The ▲ and ▼ control arrows also are used to increase/decrease numeric values of certain menu items (e.g. alarm Setpoint, cal gas concentration, etc.).

PLEASE NOTE

This manual contains illustrations of those display screen menu options generally used in the normal course of operation of the SensAlarm *Plus* Monitor. The Monitor may also display a variety of additional warning or cautionary screens. These additional display screens are instructive and self-explanatory in nature. The user should read each display screen and perform the recommended actions as required.

Important Factory Default Settings

Each Monitor is shipped from the factory with **default settings**. These include default settings for alarms, warnings and relays. **The default settings can be found in Section 12 – Appendix G: Configuration Reference (page 115)**. Please note that boxes filled with an “X” indicate a default setting for that particular alarm, warning, or relay. Additional blank copies of the Configuration Reference form can be found in Section 12. These blank forms are intended for use by the user to document user-defined changes from the factory default settings.

Table of Contents

How to Use This Manual	2
Basic Menu Controls Guide	2
Packing List and Notices	7
WARNINGS	8
1 INTRODUCTION	10
1.1 Product Versions	10
1.2 Standard Features	11
1.2.1 Universal Sensor Capability	11
1.2.2 Large Displays for Ease of Operation	11
1.2.3 Non Intrusive Operation	11
1.2.4 Transportable Calibration	11
1.2.5 Predictive Failure	11
1.2.6 AC & External DC Power Capability	11
1.3 Factory Installed Options	12
1.3.1 Test-On-Demand™ Gas Generator	12
1.3.2 Remote Sensor Operation	12
1.3.3 Communication Options	12
1.3.4 Dual Strobes	12
1.3.5 Internal 30 Minute Battery Backup	12
1.4 SensAlarm Plus Components	13
1.4.1 Sensor Interface Assembly	13
1.4.2 SensAlert Plus Sensor	13
1.4.3 Test-on-Demand™	13
1.4.4 Sensor Holder	13
1.4.5 Rainshield	13
1.4.6 Calibration Plug Assembly	13
1.4.7 Liquid Crystal Display and Magnetic Controls	15
1.4.8 Sensor Types	16
1.4.9 SensAlarm Plus Housing	17
1.4.10 SensAlarm Plus Power Available LED (3)	17
1.4.11 Red Strobe	17
1.4.12 Amber Strobe (option)	18
1.4.13 Sounder	18
1.4.14 Reset Button	18
1.5 Electronics Modules	19
1.5.1 Display PCA	20
1.5.2 LED display (4-digit) PCA	20
1.5.3 Power Assembly TB1, TB2	20
1.5.4 Barrier PCA	21
1.5.5 AC Power supply	21
1.5.6 Main PCA	21
2 INSTALLATION	22
2.1 Location	22
2.2 Fire or other Code Compliance Issues and annunciation requirements	22
2.3 Monitor Installation	22
2.3.1 AC Power	24

2.3.2	DC Power	25
2.3.3	Wiring Procedure (4-20 mA Output)	25
2.3.4	Wiring Procedure (Relay Outputs)	25
	Start Up.....	26
3	OPERATING FUNCTIONS	27
3.1	Calibration	27
3.1.1	Zeroing the Monitor	28
3.1.2	Span Calibration	29
3.2	Sensor Adjustment.....	33
3.2.1	Select Calibration Gas.....	34
3.2.2	Selecting a K-Factor	35
3.2.3	Selecting a Custom K-Factor.....	37
3.3	ToD Mode Adjustment.....	38
3.3.1	Auto Mode, Enable/Disable	39
3.3.2	ToD Auto Mode, Test Date/Time.....	40
3.3.3	ToD Auto Mode, Days Between Tests	41
3.3.4	ToD Mode Adjustment, Cell Intensity	41
3.3.5	ToD Mode Adjustment, Output Indicators	42
4	ALARMS, FAULTS AND RELAYS	43
4.1	Alarms	44
4.1.1	Add a Relay	45
4.1.2	Delete a Relay	46
4.1.3	Enable or Disable an Alarm.....	46
4.1.4	Ascending or Descending alarm threshold.....	47
4.1.5	Alarm Setpoint	47
4.1.6	Release Offset.....	48
4.1.7	TWA Average Time Adjustment.....	48
4.2	Fault Functions.....	49
4.2.1	Add a Relay	50
4.2.2	Delete a Relay	51
4.2.3	Enable or Disable a Fault	51
4.2.4	Adjust Fault Current.....	51
4.2.5	Adjust Fault Current Delay	51
4.3	Warn Current – Relay 5	52
4.3.1	Warn Current-Relay 5, Latching/Non-Latching	52
4.3.2	Warn Current – Relay 5, Enable or Disable	53
4.3.3	Low Current Time Adjust.....	53
4.4	Relay 1-Fail, Relay 2, Relay 3, Relay 4	54
4.4.1	Latching or Non-Latching	54
4.4.2	Norm Energized/ Norm De-Energized.....	55
4.4.3	Time Delay.....	55
4.5	Horn – Relay 6	56
4.5.1	Latching or Non-Latching	56
4.5.2	Timeout (Enabled/Disabled).....	57
4.5.3	Time Delay.....	57
4.5.4	Timeout Delay.....	58
4.6	Red Strobe - Relay7, Amber Strobe-Relay8.....	58
4.6.1	Latching or Non-Latching	58
4.6.2	Norm Energized/ Norm De-Energized.....	59

4.6.3 Time Delay 60

5 MENU STRUCTURE & MAP..... 61

Basic Guide to Using the Menu System 61

SENSALARM PLUS Menu Structure 61

5.1 Main Menu Screen 61

5.2 Main Menu (screens)..... 89

As shown on the example display to the right, the top level (main) menu allows the selection of several submenus, documented below. Selecting OK brings up the submenus..... 89

5.2.1 Calibration Mode..... 89

5.2.2 Zero Monitor..... 89

5.2.3 Calibrate..... 89

5.2.4 Set Cal Gas Concentration 90

5.2.5 Maintenance Mode 90

5.2.6 Data Review..... 90

5.2.6.1 Calibration Info 91

5.2.6.2 Sensor Status..... 91

5.2.6.3 Sensor Data 91

5.2.6.4 Active Alarms/Faults..... 91

5.2.6.5 Fault Currents..... 92

5.2.6.6 Fault Current Delay 92

5.2.6.7 Rly Alm Fault Config..... 92

5.2.6.8 ToD Review 93

5.2.6.9 Communication Review..... 93

5.2.6.10 Firmware Review..... 93

5.2.7 Test-On-Demand (Main Menu) 94

5.2.8 System Configuration 94

5.2.8.1 Self Test 94

5.2.8.2 Alarm Settings 95

5.2.8.3 4/20 mA Adjustment 101

5.2.8.4 Adjust Date/Time..... 101

5.2.8.5 Communication Setup 101

5.2.8.6 ToD Mode Adjustment..... 102

5.2.8.7 Sensor Adjustment 103

5.2.8.8 Set Password 103

5.2.8.9 Reset Defaults..... 105

5.2.8.10 Set Monitor Tag..... 105

6 PRODUCT NUMBERS & PARTS LIST..... 106

6.1 Monitors 106

6.2 Sensors..... 106

6.3 Options & Accessories 106

6.4 Spare Parts..... 106

6.5 Calibration Equipment 107

6.6 Zero Calibration Gases..... 107

6.7 Calibration Gases¹ 107

7 APPENDIX A: DECLARATION OF CONFORMITY..... 109

8 APPENDIX B: SPECIFICATIONS..... 110

9 APPENDIX C: TROUBLESHOOTING GUIDE 111

10 APPENDIX D: TUV CERTIFICATION..... 113

11 APPENDIX F: RETURNED MATERIAL AUTHORIZATION 114

12 APPENDIX G: CONFIGURATION REFERENCE 115

13 APPENDIX H: MOUNTING DRAWINGS 121

Packing List and Notices

You should have the following items:

SensAlarm Plus, Universal Gas Monitoring System User Manual
A SensAlert Plus Sensor Datasheet (1 – 4 pages)
A reversible black screwdriver with magnetic end
A gray PVC Sensor Shield
User Manual (this document)

SensAlert Plus Sensor is sold separately.

Please contact factory for a complete list of available sensors.

Verify that you have received all of the items listed above. If you have any questions or need assistance, contact your Sensidyne Representative, or call 800-451-9444 or +1 727-530-3602

PROPRIETARY NOTICE

This manual was prepared by Sensidyne, LP exclusively for the owners of the SensAlarm Plus Universal Gas Monitoring System. The material within this manual is the proprietary information of Sensidyne, LP and is to be used only to understand and operate the instrument. By receiving this document, the recipient agrees that neither this document nor the information disclosed within nor any part shall be reproduced or transferred, physically, electronically or in any form or used or disclosed to others for manufacturing or for any other purpose except as specifically authorized in writing by Sensidyne, LP.

COPYRIGHT NOTICE

© 2009, Sensidyne, LP, all rights reserved. Information contained in this document is protected by copyright. No part of this document may be photocopied, reproduced, or translated to another program or system without prior written authorization from Sensidyne, LP

TRADEMARK NOTICE

Sensidyne, the Sensidyne logo, SensAlert, SensAlarm, SensAlarm Plus, the SensAlert & SensAlert Plus logos, ToD & Test-on-Demand are registered trademarks of Sensidyne, LP. The trademarks and service marks of Sensidyne, LP are protected through use and registration in the United States of America.

SOFTWARE LICENSE

The software included with the SensAlarm Plus Gas Monitor is the property of Sensidyne, LP and shall remain the property of Sensidyne, LP in perpetuity. The software is protected by U.S. and international copyright laws and is licensed for specific use with the SensAlarm Plus Universal Gas Monitoring System. The user may not reverse-engineer, disassemble, decompile, or make any attempt to discover the source code of the software. The software may not be translated, copied, merged or modified in any way. The user may not sublicense, rent, or lease any portion of the software. The right to use the software terminates automatically if any part of this license is violated.

DISCLAIMER

SENSIDYNE, LP ASSUMES NO RESPONSIBILITY WHATSOEVER, TO ANY PARTY WHOSOEVER, FOR ANY PROPERTY DAMAGE, PERSONAL INJURY, OR DEATH CAUSED BY OR RESULTING FROM, IN WHOLE, OR IN PART, THE IMPROPER USE, INSTALLATION, OR STORAGE OF THIS PRODUCT BY THE USER, PERSON, FIRM, ENTITY, CORPORATION OR PARTY NOT ADHERING TO THE INSTRUCTIONS AND WARNINGS OR NOT ADHERING TO ALL FEDERAL, STATE, AND LOCAL ENVIRONMENTAL AND OCCUPATIONAL HEALTH AND SAFETY LAWS AND REGULATIONS.

THE SELLER SHALL NOT BE LIABLE FOR DIRECT, INDIRECT, CONSEQUENTIAL, INCIDENTAL OR OTHER DAMAGES RESULTING FROM THE SALE AND USE OF ANY GOODS AND SELLER'S LIABILITY HEREUNDER SHALL BE LIMITED TO REPAIR OR REPLACEMENT OF ANY GOODS FOUND DEFECTIVE. THIS WARRANTY IS IN LIEU OF ALL OTHER WARRANTIES, EXPRESSED OR IMPLIED, INCLUDING BUT NOT LIMITED TO THE IMPLIED WARRANTIES OF MERCHANTABILITY AND FITNESS FOR USE OR FOR A PARTICULAR PURPOSE WHICH ARE EXPRESSLY DISCLAIMED.

WARNINGS

READ AND UNDERSTAND ALL WARNINGS AND INSTRUCTIONS BEFORE USE

Failure to read, understand, and comply with ALL accompanying literature, instructions, product labels, and warnings could result in property damage, severe personal injury, or death.

Product is tested and calibrated at the factory prior to shipment. However, this product must be calibrated prior to initial use and at regular intervals in accordance with this User Manual to ensure proper operation.

Failure to calibrate and operate this product in accordance with this User Manual may result in the malfunction of the product.

Read and understand ALL applicable federal, state, and local environmental health and safety laws and regulations, including OSHA. Ensure complete compliance with ALL applicable laws and regulations before and during use of this product.

The user/installer must understand the Hazardous Area Protection Concepts and Area Classifications applicable to their operation.

UNDER NO CIRCUMSTANCES should this product be used except by qualified, trained, technically competent personnel and not until the warnings, User Manual, labels, and other literature accompanying this product have been read and understood.

ALWAYS wash your hands thoroughly after handling, calibrating, or servicing this product.

ALWAYS wear eye protection (such as safety goggles), face shield, chemical resistant gloves and chemical resistant clothing when handling chemicals, or calibration sources.

DO NOT get chemicals, gases, fumes, or vapors in your eyes or on your skin, as they may cause severe burns to skin and eyes. If chemicals, gases, fumes, or vapors get in your eyes or on your skin, wash the affected area with copious amounts of water and call a physician immediately.

ALWAYS avoid any contact of acids with your skin or eyes. Seek immediate medical attention for any contact with acids.

ALWAYS calibrate in a well ventilated area. Adequate precautions should be taken to prevent the buildup of ANY calibration sources or vapors. Avoid breathing ANY calibration fumes or vapors as they may be hazardous to your health.

ALWAYS dispose of chemicals and calibration sources in compliance with ALL applicable safety laws, regulations, and guidelines for proper disposal. Failure to do so may result in environmental damage, property damage, personal injury or death.

ALWAYS close ALL containers of chemicals used with this product after use.

ALWAYS ensure that any compressed calibration substance sources are empty prior to disposal, should they be used.

ALWAYS use clean, dry, inert materials to contain and transfer substances used for calibration.

DO NOT remove, cover, or alter any label or tag on this product, its accessories, or related products.

DO NOT operate this product should it malfunction or require repair. Operation of a malfunctioning product or a product requiring repair may result in serious personal injury or death.

DO NOT attempt to repair or modify instrument, except as specified in the Operation & Service Manual. If repair is needed, contact the Sensidyne Service Dept. to arrange for a Returned Material Authorization (RMA) (See Section 0 for details).

ALWAYS operate this product in its intended manner. Failure to do so may result in serious personal injury or death.

Users should refer to MSDS and suppliers' instructions for proper safety instructions and handling for any chemicals used with this equipment.

WARNINGS

READ AND UNDERSTAND ALL WARNINGS BEFORE USE

Use ONLY genuine SENSIDYNE® replacement parts when performing any maintenance procedures described in this manual. Failure to do so may seriously impair instrument performance. Repair or alteration of the product beyond the scope of these maintenance instructions, or by anyone other than an authorized SENSIDYNE® service technician, could cause the product to fail to perform as designed and persons who rely on this product for their safety could sustain severe personal injury or death.

The SensAlarm Plus Universal Gas Monitoring System is an ambient air monitoring device. Restricting the access of ambient air to the sensor may result in less than optimal monitoring performance.

Prolonged exposure to excessively high concentrations of Toxic gas may cause the sensor to produce erroneous readings.

Always make use of a Rainshield to protect against variations caused by environmental conditions. *Note that reactive Gases such as ETO, HF, HCN, NO₂, SO₂, HCl, ClO₂, or Cl₂ are not compatible with the Rainshield.*

Perform tests only within the specified operating ranges.

Sudden changes in pressure may cause temporary fluctuations in the sensor reading.

Sensors should be hot-swapped only when the Normal Operation Mode screen is displayed.



Caution - Failure to read and understand the User Manual may result in preventable severe personal injury or death.



Caution, risk of electric shock if front cover is opened.

Important Calibration Considerations:

Verify the concentration of calibration gas before making calibration adjustments.

The concentration can be altered by:

Deterioration of the gas concentration during storage.

Interaction of the calibration gas with materials used to contain and transfer the gas (tubing), as for example, absorption onto and permeation through certain plastics, polymers and elastomers.

Interaction of the calibration gas with ambient contaminants, such as water.

If further translation is required, please contact the Sensidyne EU Authorized Representative (see Back Cover for contact information).

1 Introduction

This manual provides specific information concerning the installation, operation, calibration, and maintenance of the SensAlarm Plus Universal Gas Monitoring System. SensAlarm Plus is capable of detecting the presence of potentially hazardous concentrations of Combustible vapors and gases, Toxic gases and Oxygen deficiency.

1.1 Product Versions

The SensAlarm Plus Gas Monitor is offered with no strobe, single, and dual strobe Versions each with or without Battery Back up.

SENSALARM PLUS ASSEMBLY PART NUMBERS for OPTIONS

NO STROBE

820-0302-01 NO STROBE
820-0302-02 NO STROBE WITH BATTERIES

SINGLE STROBE

820-0301-01 RED STROBE
820-0301-02 RED STROBE WITH BATTERIES
820-0303-01 BLUE STROBE
820-0303-02 BLUE STROBE WITH BATTERIES
820-0304-01 AMBER STROBE
820-0304-02 AMBER STROBE WITH BATTERIES

DUAL STROBE

820-0301-03 AMBER & RED STROBE
820-0301-04 AMBER & RED STROBE WITH BATTERIES
820-0305-01 AMBER & BLUE STROBE
820-0305-02 AMBER & BLUE STROBE WITH BATTERIES

A standard SensAlarm Plus Monitor consists of electronics modules (PCAs) in a fiberglass enclosure, a sensor interface assembly, and a plug-in sensor specifically designed to detect a target gas or vapor.

A large format 4-Digit LED display provides readout for gas concentration. A strobe (or dual strobes, see options) flashes during configured alarm and warning conditions. A 95dB sounder also activates during the alarm and warning conditions. The sounder can be silenced with a red pushbutton switch. The alarm reset conforms to ISA alarm sequence 3A

Product specifications for the SensAlarm Plus are in Appendix B, Specifications.



1.2 Standard Features

1.2.1 Universal Sensor Capability

The SensAlarm *Plus* Monitor unit accepts a variety of sensor technologies, including electrochemical, catalytic bead Combustible, and infrared Combustible. Sensors can be installed without having to reconfigure or modify the Monitor in any way. When a different SensAlert *Plus* sensor type is installed in the Monitor the unit completely reconfigures the system functions to match those of the new sensor. This includes changing all alarm and calibration settings to match those of the new sensor.

1.2.2 Large Displays for Ease of Operation

The Monitor has a large format 4-digit LED display for gas concentration and a backlit LCD with magnetic controls.

1.2.3 Non Intrusive Operation

Four magnetic switches on the backlit LCD allow full configuration, calibrations and other functions to be performed without opening the Monitor enclosure. A magnetic screwdriver is provided with the Monitor.

1.2.4 Transportable Calibration

SensAlert *Plus* sensors have transportable calibration capabilities. Sensors may be calibrated in the shop or at Sensidyne and then installed in the field without any special tools or adjustments. When a new sensor is installed in the unit, the Monitor automatically adjusts to recognize the new gas type and range and adjusts system function accordingly.

1.2.5 Predictive Failure

Predictive Failure is a unique feature that provides the user with an early warning of the pending expiration of a sensor. When the sensor has less than 10% of its life remaining, a warning appears on the main display, and can be assigned to activate other warning indicators.

Predictive failure is based on sensor age, power on hours, calibration gain and cumulative gas exposure. *The user can also display Remaining Sensor Life (percent) at any time.*

1.2.6 AC & External DC Power Capability

SensAlarm *Plus* has an internal power supply for operation from 100-240 VAC, 50/60 Hz and rated at 24 VDC, 65 watts output. 24 VDC is used to power the annunciation, so that the Monitor is fully functional on external 24 VDC or internal battery back-up when furnished.

The optional, internal battery back-up will power the unit in the event of a power failure. It provides 30 minutes operation in full alarm and 60 minutes minimum when not in alarm, depending upon the installed sensor type.

1.3 Factory Installed Options

1.3.1 Test-On-Demand™ Gas Generator

The SensAlert *Plus* Test On-Demand™ (ToD) feature allows the gas sensor response to be confirmed quickly and easily. When activated, either manually, or at programmed times, the ToD™ cell generates a small gas output which should produce a signal from the gas sensor to verify that it is responsive to gas. This un-manned “bump test” does not replace recommended calibration procedures. The purpose of this feature is to provide a higher level of system operating confidence by confirming that the sensor responds to gas. This feature can be activated via the LCD display, or automatically using the Test Date/Time menu. Environmental conditions or ToD cell depletion can cause this test to fail. A low mA signal for 30 seconds will indicate failure or a relay may also be assigned.

1.3.2 Remote Sensor Operation

The sensor is mounted in a sensor interface assembly on the bottom of SensAlarm *Plus*. It can, however, be located up to 100 feet away. In this manner, the detection of heavier or lighter than air gases and the use of special fixtures such as sample draw or duct mounting can be easily done.

The sensor interface is connected without special cable or conduit. Sensidyne furnishes all hardware to remote mount the sensor except for the 4 conductor shielded cable.

1.3.3 Communication Options

An optional Communications PCA can be installed for RS-485 Modbus Protocol, or HART Protocol.

821-0221-01 RS 485, Modbus Protocol
821-0220-01 HART

1.3.4 Dual Strobes

When two strobes are ordered, an Amber strobe will be mounted on the left side and the Red strobe will be on the right. *Different color strobe lens are available, consult the factory.*

1.3.5 Internal 30 Minute Battery Backup

An integral battery back-up option with internal charging is offered for those applications with frequent power interruptions, or to provide SensAlarm *Plus* operation in the event of power failure. If a gas alarm occurs during battery back-up, **a minimum of 30 minutes operation is available**. The unit will operate for a much longer time if there are no alarms and depending upon the installed sensor type.

1.4 SensAlarm Plus Components

1.4.1 Sensor Interface Assembly

The sensor interface assembly contains the electronics that operate the sensor and houses the SensAlert Plus sensor and the optional Test-on-Demand™ cell.

1.4.2 SensAlert Plus Sensor

SensAlert Plus Sensors are available in a variety of sensor technologies for detecting Toxic, Oxygen, and Combustible gases. The SensAlert Plus Sensor is discussed in greater detail in Section 1.4.8. The sensor gasket seals the sensor inside the sensor holder.

1.4.3 Test-on-Demand™

The optional Test-on-Demand™ (ToD™) gas generating cell provides a method for periodic sensor response verification (programmed or manually activated). The T-O-D gasket seals the generating cell inside the sensor holder.

1.4.4 Sensor Holder

The sensor and ToD™ gas generating cell are housed in the Sensor Holder. The sensor holder is easily installed and removed via the retaining ring located on the sensor interface assembly. The sensor holder is black anodized Aluminum and optional gray PVC.

1.4.5 Rainshield

The optional rainshield protects the sensor and ToD cell from liquid intrusion due to rain, splash-back, or unintentional washdown. Reactive Gases such as ETO, HF, HCN, NO₂, SO₂, HCl, ClO₂, or Cl₂ are not compatible with the Rainshield.

1.4.6 Calibration Plug Assembly

The calibration plug assembly secures into the sensor shield or replaces the Rainshield when the Monitor is being calibrated.



Single or Dual Strobes
(Red or Amber and Red)

Large Format LED Display

Power Source Available LEDs
AC External DC Battery

Magnetic Controls (OK <<)

LCD Display

Magnetic Controls (▲ ▼)

Reset Switch
And Sounder

Interface Assembly
(Sensor Head)



1.4.7 Liquid Crystal Display and Magnetic Controls

The Liquid Crystal display is backlit and has a contrast adjustment.

1 Gas Concentration or Value

The gas concentration is displayed in large characters with the units of measure (ppm, %vol, %LEL), as required by the installed sensor. This information is automatically retrieved from the sensor on power up.

2 Gas Type & Maximum Sensor Range

Displays the chemical symbol or abbreviated name of the target gas sensor installed in the Monitor. *The range of the sensor is displayed to the right on the same line.*

3 Local Date and Time

The date can be user formatted. The time is displayed in a 24 hour format.

4 Monitor Name or ID

User-entered field for Monitor identification.

5 OK Control (Magnetic Switch)

OK is one of the four magnetic switches used to operate the SensAlarm Plus menu. OK is used to **confirm** operations or **select** a menu item. Activating OK from the Main Display brings up a menu listing the operations that can be performed.

6 << (Go Back)

<< is the opposite of OK. If you change your mind while performing any operation, activating << will take you back to the previous operation.

7 ▲ and ▼

The ▲ and ▼ control arrows are used to scroll up or down the menu and to increase or decrease a value (such as an alarm Setpoint). Holding the wand near these magnetic switches causes the displayed value to increase or decrease.

8 Red LEDs 1 through 4

The LCD display has four Red LEDs that light to confirm that magnetic switch contact has been made with the magnetic wand. They also light when an alarm or fault condition is occurring.

Each Red LED is also associated with the respectively numbered alarm relays. LED 1 (Relay 1) is factory set as the “fault” LED/Relay. LED 2, 3 and 4 are associated with relays 2, 3, and 4.

9 This line is used for important system messages and warnings such as “Alarm 1 is On.”

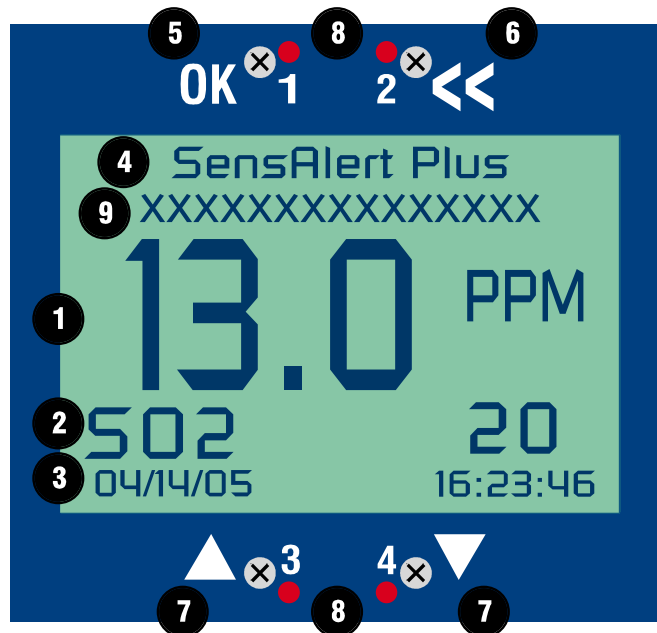

1.4.8 Sensor Types

NOTE

DO NOT attempt to install any other sensor type into a SensAlarm *Plus* except those manufactured by Sensidyne and intended for this product.

A complete list of available sensors, sensor specifications, interferences, and calibration equipment can be found on line at www.sensidyne.com.

Sensors should be hot-swapped only when the Normal Operation Mode screen is displayed.

Sensor Types

Infrared

Infrared sensors are used to detect Combustible gases or vapors and Carbon Dioxide.



Catalytic Bead Combustible

Catalytic Bead sensors are used to detect Combustible gases and vapors.



Sealed Electrochemical

Sealed electrochemical sensors are used to detect Toxic gases.



Oxygen

Oxygen sensors are used to monitor ambient Oxygen levels to detect Oxygen Deficiency.



Sensor Assembly

The sensor assembly consists of a gas sensor attached to a circuit board. An EEPROM on the circuit board contains essential sensor identification information that is communicated to SensAlarm *Plus* during sensor installation. This information allows the sensor to be calibrated in the shop or at Sensidyne and hot-swapped in the field without further calibration.

Note: Oxygen and Infrared Sensors must be calibrated at the altitude of use.

NOTE

The ETO, NO and 100 PPM HCl sensors are shipped with battery boards attached to maintain a sensor bias. Batteries are designed to maintain biasing for up to 90 days. Battery boards should remain attached to the sensor until just prior to sensor installation, and should be removed in a non hazardous (classified) safe area just prior to installation of the sensor into the SensAlarm *Plus* Monitor. The sensor can be unplugged from the battery board for a maximum of 5 minutes. Note that, if unplugged or unpowered for 15 seconds, a sensor may take 2 minutes to return to zero once it is plugged into a Monitor or powered up. If unplugged or unpowered for 5 minutes, a sensor may take several hours to return to zero once it is plugged into a Monitor or powered up.

NOTE

If the sensor is not installed or not completely engaged, “Missing Sensor” is displayed on LCD display. The Monitor’s 4-20mA output returns a “Loop-Fail” condition by providing an unvarying default output of < 3.0 mA (user adjustable 1-4mA).

1.4.9 SensAlarm *Plus* Housing

The product housing is a NEMA 4X Fiberglass enclosure. When the optional battery back-up is ordered, the enclosure is vented and the rating becomes NEMA 3R, IPX4. The raw enclosure is UL listed.

1.4.10 SensAlarm *Plus* Power Available LED (3)

Three green LEDs are below the large format display to indicate what power sources are available for operation. Normal operation would be from AC power or external 24 VDC power. **Note that both LEDs (AC Power, External DC) will be on when both power sources are available.**

Installed integral battery back-up is indicated by the third LED being illuminated. This power source will only be used in the event that the primary power source(s) are not available.

1.4.11 Red Strobe

The standard base SensAlarm PLUS includes one Red Strobe Annunciation light which actuates on low and high alarms. The strobe is a double flash, high recognition unit approved to SAE J1318 Class 3 for gaseous discharge warning lamps. The 2.2 Joule strobe has Fresnel lens optics and double-flashes 70 times per minute.

MAINTENANCE

WARNING: High voltage generated by the light’s power supply may cause property damage, serious injury or death to you or others. Ensure that power to light is disconnected and wait at least 5 minutes before working on the light. As strobe lights are used, the flash tubes begin to darken, decreasing light output. Also, as flash tubes age, they may have a tendency to misfire. After extended operation, occasionally check for flash tube degradation. Should the flash tube misfire, have a noticeable decrease in light output or glow continuously, it should be replaced. To replace the flash tube, proceed as follows:

- Disconnect power.
- BE CAREFUL!** Use GLOVES and EYE PROTECTION to avoid personal injury in the following procedure.
- Twist the lens (1) counter-clockwise to remove it from the base.
- The Flash tube can be removed by grasping and pulling upward on the white potted base.

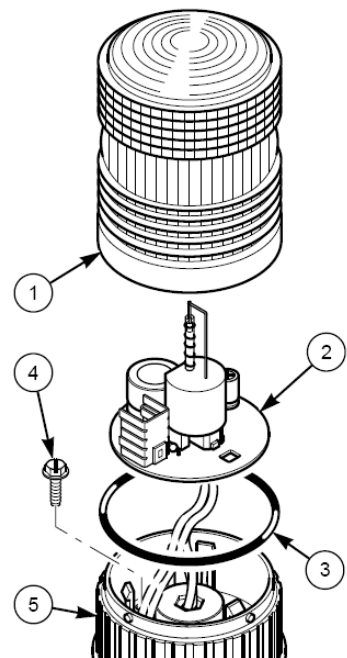

- E. CAUTION: The service life of the new strobe tube will be shortened if the glass portion is touched. If glass has been handled, clean carefully with a grease solvent.
- F. Install a new flash tube. Observe handling caution.
- G. Reassemble the light by replacing the lens.
- H. Reconnect power and test for proper operation.

1.4.12 Amber Strobe (option)

A second strobe is optional for SensAlarm PLUS. When this is ordered, An Amber strobe is placed on the left and the Red strobe is on the right. The Amber strobe will flash on low alarm and high alarm. The red strobe flashes only on high alarm. The strobe specifications and maintenance are the same as described above.

1.4.13 Sounder

A 95dB Piezo horn is located on the bottom right side of the enclosure. The sounder activates during alarm and warning conditions. The sounder can be silenced with a red pushbutton switch. The alarm reset conforms to ISA alarm sequence 3A.

1.4.14 Reset Button

SensAlarm PLUS has a Red Alarm Reset Pushbutton on the bottom right side of the enclosure. This Pushbutton can be used to reset or release a latched Alarm Relay and / or to silence the Piezo horn on the enclosure. This function conforms to ISA Alarm Sequence 3A, that is, when the local horn is silenced, the Strobe Annunciation will continue to flash and the associated Alarm Relays will remain energized. If the unit goes out of alarm and then back into alarm, the horn will resume until the Reset Pushbutton is depressed again.

The high Alarm Relay in SensAlarm is not affected by the Reset Button so a remote horn cannot be silenced. The latched Alarm relays can only be released by pushing the Reset button, however they will release only when the unit is not in Alarm.

1.5 Electronics Modules

The electronic modules operate the sensor, determine sensor response, actuate the alarm relays, turn on the annunciation (horn and strobe), converts the sensor response into a 4–20 mA current, linearly proportional to the concentration of the target gas present at the sensor, and optionally provide RS 485 Modbus or HART communications protocol output. The sensor response reading is displayed on both the LCD and large format LED Displays.

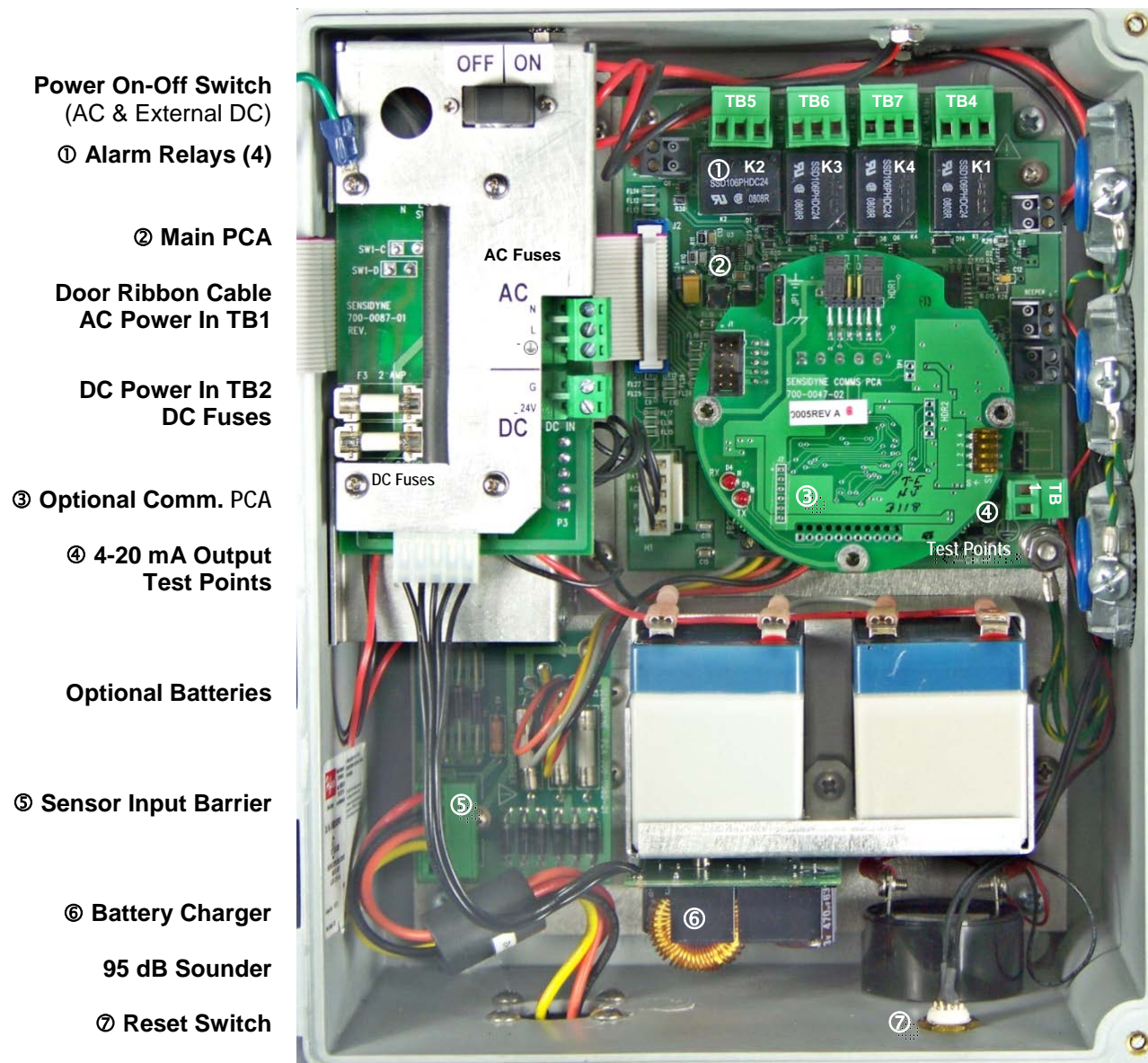

Power On-Off Switch
(AC & External DC)

① **Alarm Relays (4)**

② **Main PCA**

Door Ribbon Cable
AC Power In TB1

DC Power In TB2
DC Fuses

③ **Optional Comm. PCA**

④ **4-20 mA Output**
Test Points

Optional Batteries

⑤ **Sensor Input Barrier**

⑥ **Battery Charger**

95 dB Sounder

⑦ **Reset Switch**

The SensAlarm Plus Monitor has non-intrusive controls that do not require the enclosure to be opened for calibration, alarm adjustment, or other functions. However, test points are provided on the main PCA in case service personnel wish to monitor the output.

An internal 10 ohm resistor between test points **TP2** and **TP3** in series with the output loop current of 4–20 mA produces a voltage across the test points of 40–200 mv, corresponding to the sensor range.

NOTE

A HIGH IMPEDANCE VOLTMETER (PREFERABLY DIGITAL), WITH A MINIMUM FULL SCALE CAPABILITY OF 200 MV AND A RESOLUTION OF ± 1 MV, IS REQUIRED TO MONITOR VOLTAGE AT THE TEST POINTS.

1.5.1 Display PCA

The front and rear views of the Display LCD PCA are shown below about half of actual size on the printed page. The Display PCA back is barely visible inside the front cover of SensAlarm Plus. The display contrast adjustment can be reached with a finger.

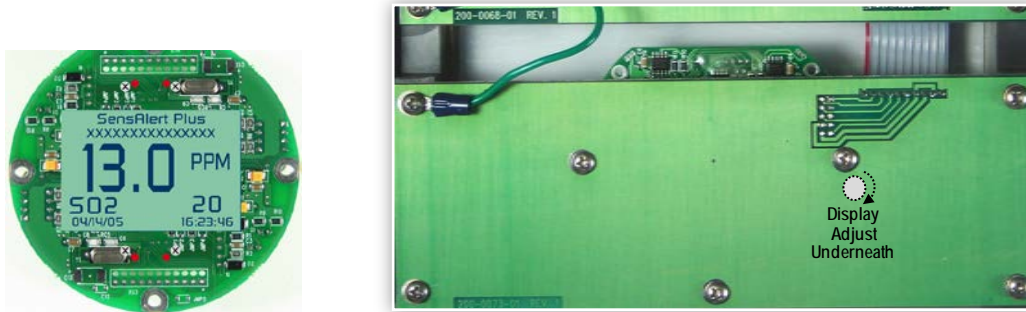

1.5.2 LED display (4-digit) PCA

The front and rear views of the large format display are shown below about half of actual size on the printed page. There are no user adjustments.

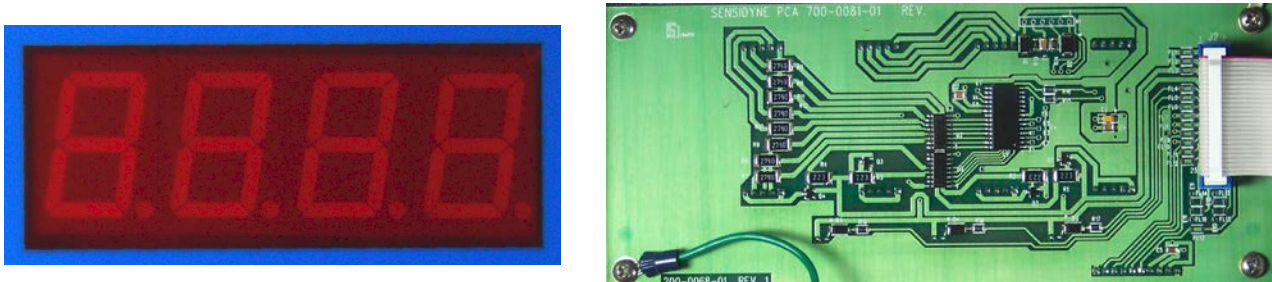

1.5.3 Power Assembly TB1, TB2

AC Power and, or External 24 VDC Power are connected to TB1 and TB2, respectively. The external DC power fuses are shown on the lower left. The AC fuses are located under the metal shroud for safety and can be accessed by removing the four (4) screws.

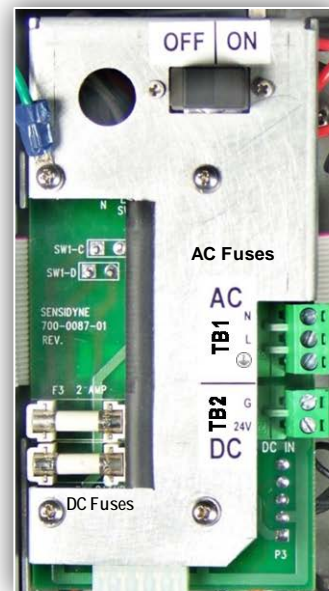

1.5.4 Barrier PCA

The barrier PCA is an intrinsic safety barrier for the sensor interface and is located in the lower left corner of the enclosure. This circuitry is not yet approved by a third party for sensor location in a hazardous (classified) area. There are no user adjustments on the barrier PCA

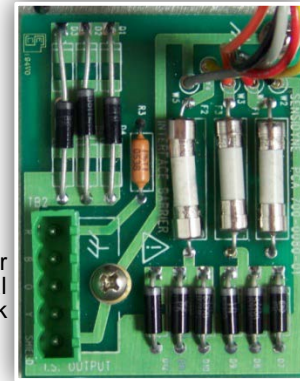

Sensor Terminal Block

1.5.5 AC Power supply

The AC power to 24 VDC power supply is mounted on edge under the power assembly (On-Off Switch, TB1, TB2 and Fuses). There are no user adjustments on the AC power supply.

1.5.6 Main PCA

The main PCA accepts the input of the sensor interface and processes the signal to provide display inputs, alarms and analog output signals. A fault relay and three alarm relays are also provided. The PCA has removable terminals for easy wiring convenience. See K1 - K4 and TB4 – TB7 above in photo at right. Also note sensor interface connector, test points, 4-20 mA terminals (TB1), Reset and Beeper connections (internal).

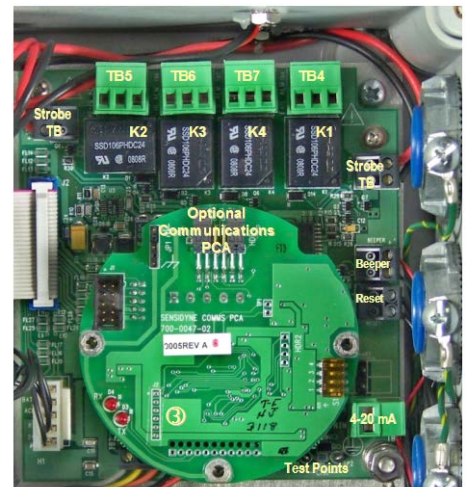

Power Interface

Sensor Interface

2 INSTALLATION

2.1 Location

Monitoring efficiency will depend upon the appropriate mounting and placement of the gas Sensor. The SensAlarm *Plus* Gas Monitor is a point (local area) gas detector which should be mounted in proximity to a potential leak source or hazard condition. The Gas Sensor is often mounted remotely from the SensAlarm *Plus* in an area containing a potential gas hazard such as a battery room, gas bottle storage area or instrument shelter. The SensAlarm *Plus* itself is conveniently located, usually near the entrance to such an area or perhaps inside depending on the annunciation requirements and whether or not an area is normally occupied.

Expert consultation may be necessary to determine the most appropriate location for optimum monitoring. In all circumstances, the plant safety officer or other appropriate personnel should be consulted before installation.

Site determination, at a minimum, must consider the following factors:

- Most probable location(s) of a hazardous gas leak
- Physical properties of the target gas (heavier or lighter than air)
- Air movement in the area due to HVAC or ambient conditions
- Operational environment (vibration, temperature, humidity, wind, etc.)
- Presence of interferent gases (see Sensor datasheet)
- Access for routine preventive maintenance

2.2 Fire or other Code Compliance Issues and annunciation requirements

The Uniform Fire Code and the International Fire Code both have evacuation requirements of buildings during emergency conditions. These mainly concern egress safety and routes, evacuation time, and include emergency lighting specifications.

If a gas detection system alarm can result in an evacuation alarm, or simply has Fire Department supervisory notification due to a hazardous material release, the system may be required to have battery or UPS type back-up power for 30 or 60 minutes. This provides for operation during a power failure, and enough time to furnish valuable status information to emergency responders.

SensAlarm PLUS is available with battery back-up to provide 60 minutes of non-alarm operation and at least 30 minutes of operation under full alarm conditions

2.3 Monitor Installation

NOTE

Always refer to the NEC and local electrical codes to ensure compliance for proper installation.

The SensAlarm *Plus* Monitor mounts directly to the wall via four (4) mounting feet (included).

The Monitor must be mounted to a wall stud or plate to properly support the weight of the Monitor.

Three (3) ¾" Rigid / IMC grounding hubs are provided for wiring access.

The top Rigid / IMC grounding hub must be used for mains connection.

The middle Rigid / IMC grounding hub must be used for relay wiring.

The bottom Rigid / IMC grounding hub must be used for DC power input, 4-20mA output.

Metal conduit should be used to achieve maximum RFI/ EMI immunity.

The Monitor must be mounted vertically ($\pm 5^\circ$ from center) with the sensor assembly pointing down.

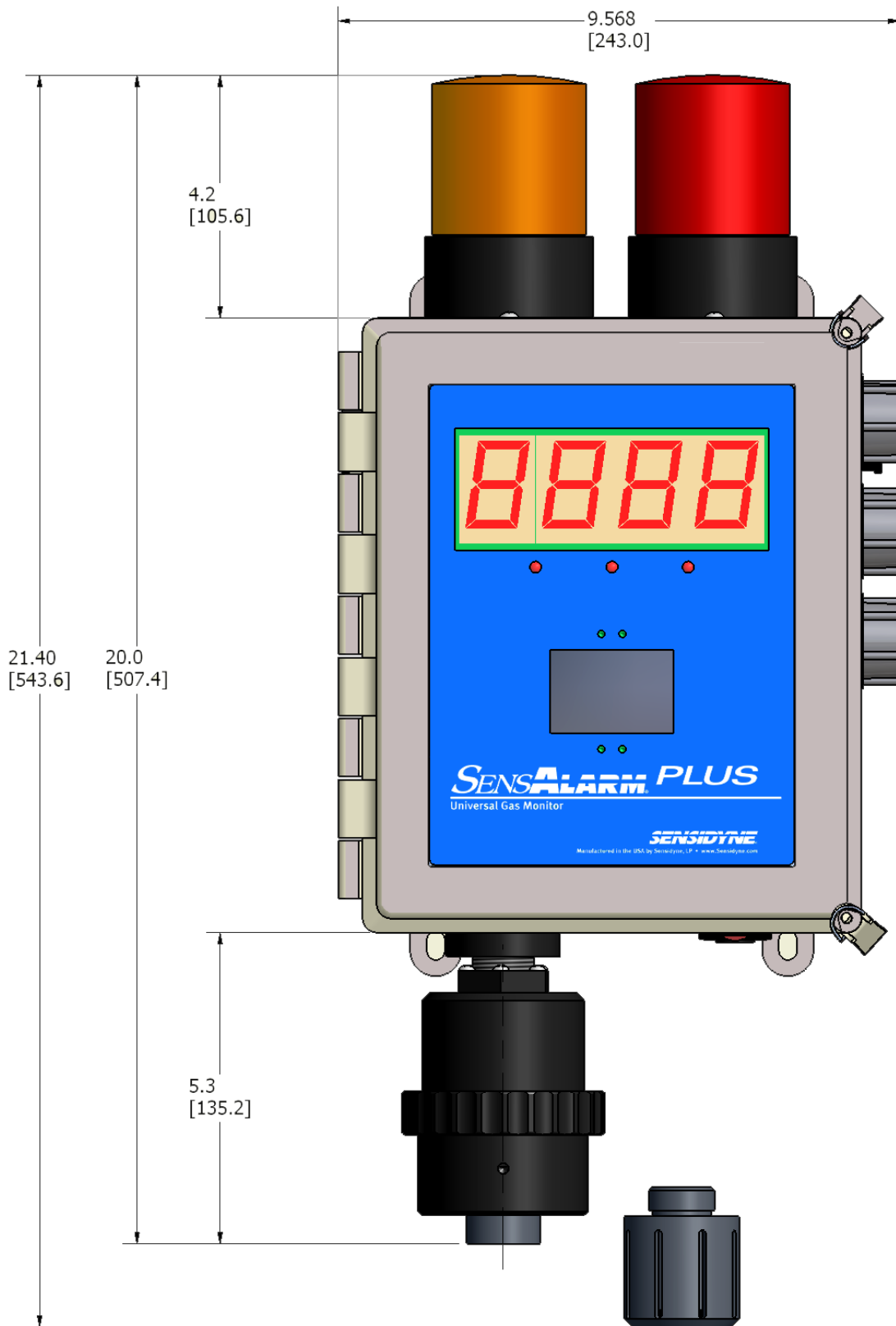

Refer to Section 13 Appendix H

Wiring

Power On-Off Switch
(AC & External DC)

① Alarm Relays (4)

② Main PCA

Door Ribbon Cable
AC Power In TB1

DC Power In TB2
DC Fuses

③ Optional Comm. PCA

④ 4-20 mA Output TB1
Test Points

Optional Batteries

⑤ Sensor Input Barrier

⑥ Battery Charger

95 dB Sounder

⑦ Reset Switch

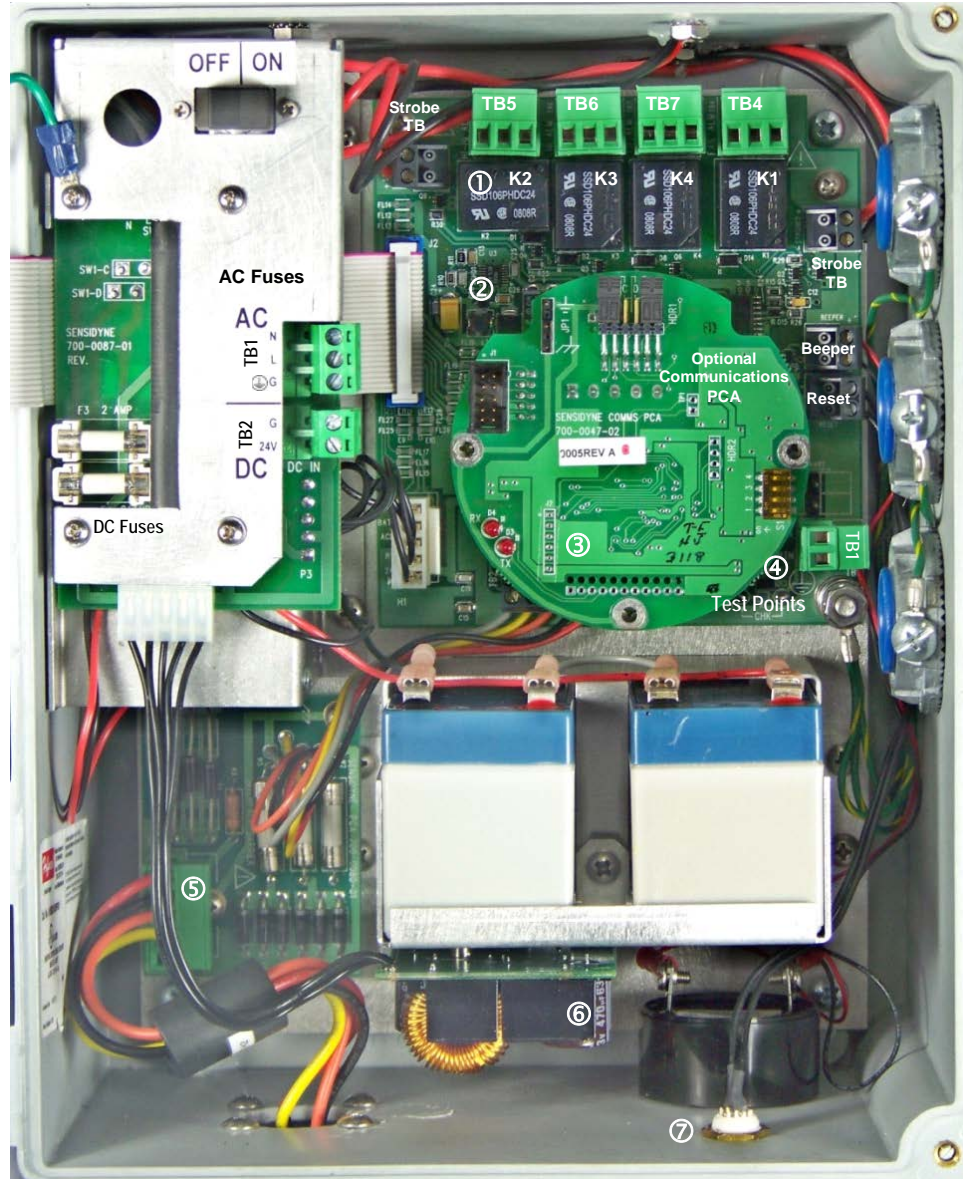

2.3.1 AC Power

AC WIRING NOTES

When wiring the Monitor to a permanent AC source, the AC source circuit breaker and/or switch must be IEC approved. The circuit breaker and/or switch must be near the unit and marked as the disconnect device. Minimum current rating must be 10 A. Minimum wire size for Mains conductor is 18 AWG. Use only U.L. listed conduit hubs that have the same or better environmental rating as the enclosure.

- 1) Unlatch and open the Monitor cover.
- 2) Confirm that the AC power is not energized, and thread the wires through the top Rigid / IMC grounding hub. (A cable that totally encases these wires is recommended.) Make certain you tighten the Rigid / IMC grounding hub sufficiently to ensure a moisture resistant seal to the cable conduit.
- 3) Make certain the Rigid / IMC grounding hub is secured tightly to the Monitor enclosure.
- 4) Loop the Mains Ground Conductor once through one of the three supplied Ferrite Beads. Repeat process for the two remaining Mains Conductors. Once complete, each Conductor should be through its own individual Ferrite Bead.
- 5) Make certain the wires are properly secured to the AC Terminal Block (TB1).

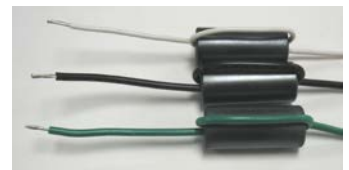

NOTE

AC (Earth) ground must terminate on TB1 ground terminal to prevent electric shock hazard.

6) Wire the relay and 4-20 mA terminals as desired using appropriate wire sizes and shielding.

2.3.2 DC Power

- 1) Unlatch and open the Monitor cover.
- 2) Confirm that the DC power is not energized, and thread the wires through the bottom Rigid / IMC grounding hub. (A cable that totally encases these wires is recommended.) Make certain you tighten the Rigid / IMC grounding hub sufficiently to ensure a moisture resistant seal to the cable conduit.
- 3) Make certain the Rigid / IMC is secured tightly to the monitor enclosure.
- 4) Make certain the wires are properly secured to the DC terminal block (TB2).

2.3.3 Wiring Procedure (4-20 mA Output)

- 1) Refer to photograph.
- 2) Verify that the conduit and the Monitor are properly connected.
- 3) Unlatch and open the SensAlarm Plus cover.
- 5) Verify that the total resistance of the wiring does not exceed the allowable loop resistance.
- 6) Thread the wires through the bottom Rigid / IMC grounding hub. (A cable that totally encases these wires is recommended.) Make certain you tighten the Rigid / IMC grounding hub sufficiently to ensure a moisture resistant seal to the cable conduit.
- 7) Connect the 4-20 mA output wire to the 4-20 mA terminal on TB1 of the Main PCA.
- 8) Connect the Return wire to the RTN terminal on TB1 of the Main PCA.
- 9) Close the Monitor cover. Secure the cover by closing the quick-release latches.

2.3.4 Wiring Procedure (Relay Outputs)

Relays 2, 3, 4 auxiliary relays are wired to be “normally de-energized” during normal operation (factory setting), while the Fault (Relay 1) alarm relay is wired to be “normally energized” during normal operation. Thread the wires through the middle Rigid / IMC grounding hub. (A cable that totally encases these wires is recommended.) Make certain you tighten the Rigid / IMC grounding hub sufficiently to ensure a moisture resistant seal to the cable conduit.

Relay 1 “Fault” K1 TB4

Wire Relay 1 as follows:

- 1) There are three terminals on the relay terminal block: A, Com, & B. Because the relay is normally energized terminal “A” = Normally Closed (NC) and terminal “B” = Normally Open (NO). The diagram at right will aid in wiring the relay.

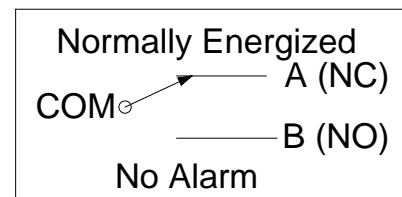

Relay 2 “Low” K2 TB5

Relay 3 “HI” K3 TB6

Relay 4 “HI HI” K4 TB7

Wire Relays 2-4 as follows:

- 1) There are three terminals on each relay terminal block: A, Com, & B. Because the relay is normally de-energized terminal “A” = Normally Open (NO) and terminal “B” = Normally Closed (NC). The diagram at right will aid in wiring the relay.

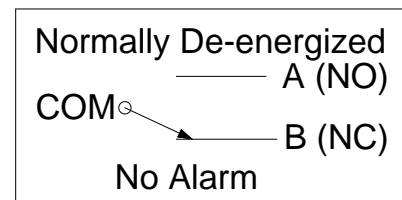

Start Up

This section contains information necessary to perform the initial start up of the SensAlarm *Plus* Gas Monitor.

To start, you need the magnetic screwdriver which was provided to complete this procedure. See Figure 2-1 (right) for component identification.

- 1) Unscrew the retainer ring (turn left to right) and remove the sensor holder by pulling downward.
- 2) Open the SensAlarm *Plus* enclosure by releasing the two corner latches. Locate and turn on the power switch and then close the cover. After the start-up screens have been displayed a “Missing Sensor” message appears.

IMPORTANT

If you have an Ethylene Oxide, NO or 100 PPM HCl sensor with a battery board, you have to remove the battery board from the sensor and install the sensor into the SensAlarm *Plus* Monitor within 20 seconds to avoid an excessive wait for the sensor to return to zero.

Biased sensors may require an extended period of time to stabilize if they have been disconnected from the battery board for more than five (5) minutes and may take several hours to return to zero once plugged in and powered up.

- 3) **Install the SensAlert *Plus* sensor** by inserting the sensor in the sensor interface assembly using the two larger mounting posts as guides. Hold the sensor by its outside edges. If force is required to engage the connector, press on the green circuit board. **To avoid damaging the sensor, do not apply pressure to the center of the sensor membrane.** To remove the sensor, pull on the circuit board edges rather than the sensor.
- 4) Once the SensAlarm *Plus* Monitor recognizes the sensor assembly, a “Warm Up” message appears on the display for 60 seconds before the Monitor begins normal operation.
- 5) As shipped, the sensor holder has a plug in the Test-on-Demand™ well. Remove this plug only if a Test-On-Demand™ cell will be installed. **Place the gasket inside the sensor holder.** Ensure the O-ring is in the sensor holder and install up over the mounted sensor by aligning with the mounting posts. Rotate the retaining ring on the assembly from right to left to secure the holder. Screw in the sensor shield.

WARNING

After power has been applied to the Monitor sensor stabilization occurs (lasting about 1 hour). During this time the sensor reading may fluctuate, possibly causing the alarms to activate (including any external alarms connected to the controller).

- 6) Allow the Monitor to stabilize at least one (1) hour before zeroing the sensor. The display reading should go toward “0” (or 20.9 %vol for ambient Oxygen sensors). After stabilization is complete indicated by a constant displayed value, go to [Section 3.1](#) and perform the zeroing procedure, even if the display is “0”.

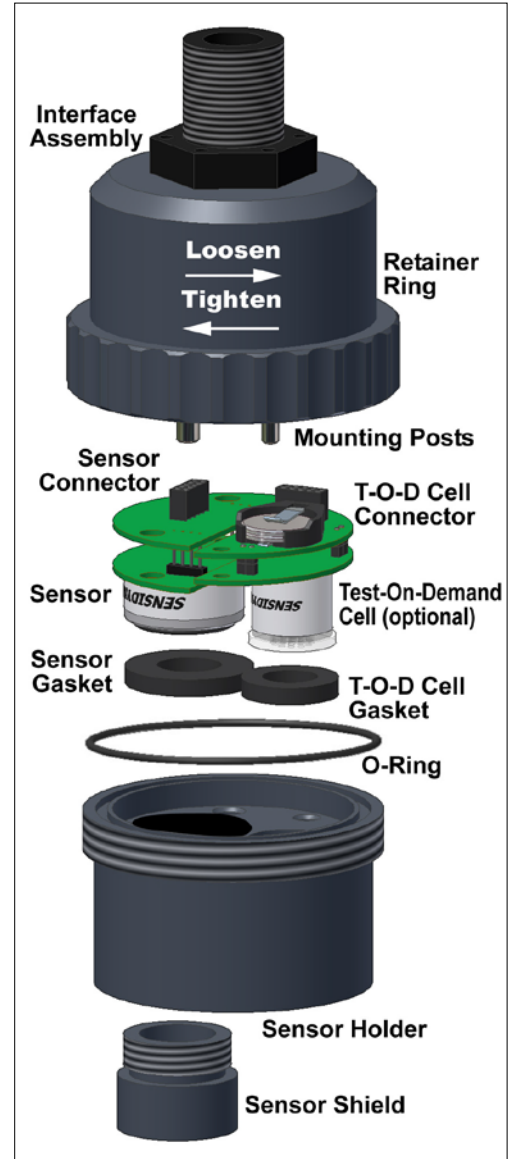

Figure 2-1
Sensor Installation

3 Operating Functions

In this Section, the procedures for performing common operating functions are presented in detail. For complete information on the structure of the SensAlarm Plus operational menu system, refer to Section 5.

3.1 Calibration

Your Sensidyne gas Monitor is tested and calibrated at the factory prior to shipment. However, this product must be calibrated prior to initial use and at regular intervals in accordance with this User Manual to ensure proper operation.

WARNING: Failure to calibrate and operate this product in accordance with this User Manual may result in the malfunction of the product.

After installation and stabilization of the gas Monitor, qualified personnel must verify calibration by applying zero and span gases. **This procedure should be performed at initial commissioning and then repeated 30 and 60 days thereafter, with deviations in zero and span recorded. The gas Monitor should then be calibrated at intervals dependent on the application, but no less often than once every 90 days except for infrared sensors which have a maximum 180 day calibration interval.**

Sensors must always be calibrated upon installation and after a gas alarm.

For further information on industry standards for sensor calibration, please refer to *Recommended Practice for the Installation, Operation, and Maintenance of Combustible Gas Detection Instruments (ANSI/ISA TR12.13.02-2003)* published by the ISA.

For a list of calibration equipment available for calibrating the SensAlarm Plus Monitor see Section 6.5: Calibration Equipment.

Always:

- Allow the Monitor to stabilize with power applied for at least 1 hour before performing any calibration.
- Set up the calibration equipment according to the instructions that came with the equipment.
- Zero the sensor prior to every span calibration.
- Refer to the Sensor Data Sheet that came with your sensor for any special instructions.
- See Appendix B: Specifications for humidity and temperature requirements.
- Use certified Bottled Calibration Gas supplied by Sensidyne.

Use of non-Sensidyne calibration gas is AT YOUR OWN RISK.

- Perform calibration at normal environmental conditions.
- Calibrate in a well ventilated area.
- Prevent buildup of any gases or vapors.
- Avoid breathing any fumes or vapors as they are hazardous to your health.
- Maintain an accurate and up-to-date Calibration Record.

To begin Calibration:

- 1) Select OK on the Normal Operation Display to bring up the Main Menu

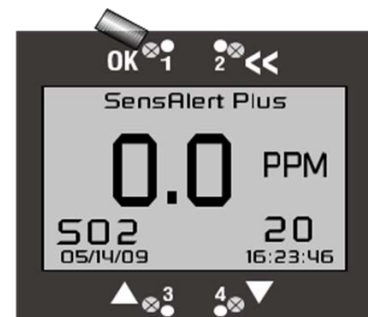

2) The cursor should be next to “Calibration Mode” if not, adjust the position using the up and down arrows.

3) Select OK to bring up the Calibration Mode menu.

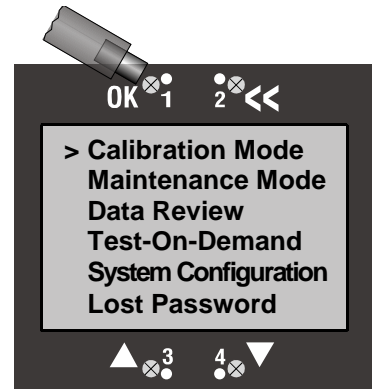

The Calibration Mode screen displays the calibration gas level, date, and time of the last successful span calibration.

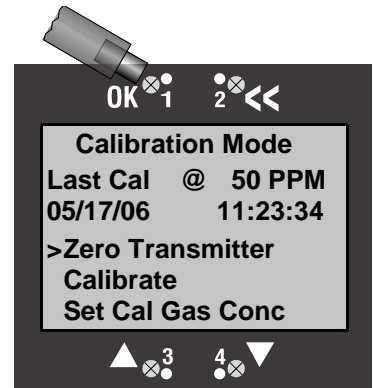

3.1.1 Zeroing the Monitor

Zeroing sets the Monitor to a baseline output for when the target gas is **NOT** present.

Note:

This procedure applies to most sensors. However, some sensors require a special zeroing procedure. i.e. Oxygen Deficiency sensors.

Refer to the “Sensor Data Sheet” that came with the installed sensor for a complete list of instructions.

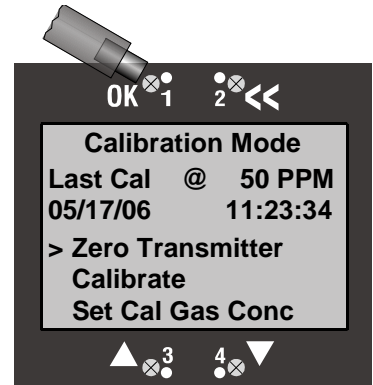

1) The cursor should be next to “Zero Transmitter” if not, select the position using the up and down arrows.”

2) Select OK.

3) When this screen appears, apply the zero gas. For some sensors, the ambient air free of the target gas will be sufficient.

4) Select OK to continue zeroing the Transmitter.

Using the << anytime before the zeroing finishes will exit the zeroing routine and restore the initial zero setting.

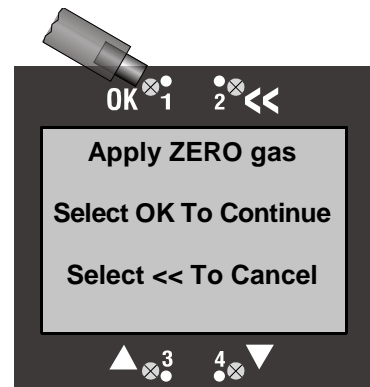

5) “Zeroing In Progress” is displayed during zeroing and typically lasts less than 60 seconds.

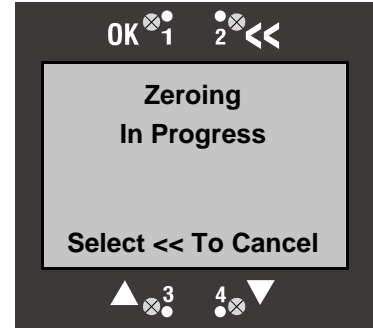

6) This screen appears when zeroing is successful.

7) Remove the zero gas.

8) Select OK to return to the Main Menu Display.

9) Select << to return to the Normal Operations Display.

Note:

If nothing is selected for 5 minutes, this screen will automatically return to the normal operations display.

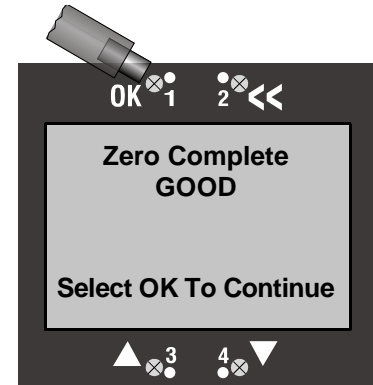

10) Zero Fail

If zeroing is not successful for any reason this screen will appear.

Repeat Zero procedure.

If Zero fails after second attempt, replace Sensor and repeat Zero.

If still unable to set Zero, contact the Sensidyne Service Department.

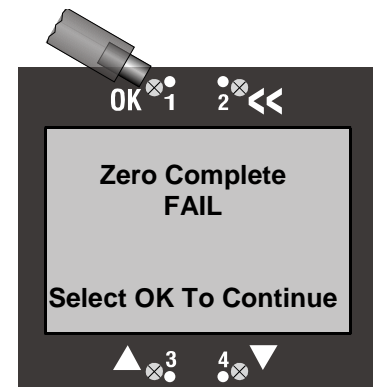

3.1.2 Span Calibration

Important information concerning sensor function is stored in sensor memory each time it is calibrated and during normal operation. Sensor data includes zero and span calibration parameters, as well as the temperature compensation characteristics for that particular sensor. This gives the SensAlert Plus sensors a special capability to be calibrated in the laboratory using one Monitor and then installed in another Monitor in the field without any further modification or recalibration.

Note:

The Monitor should also be calibrated if the sensor assembly has been replaced with an un-calibrated sensor or the Monitor has been exposed to gas concentrations at alarm levels.

Note about K-Factors:

A K-Factor is needed for combustible sensors when the target gas is different from the calibration gas (Methane or Propane). Go to Section 3.2.2 and select a K-Factor before calibrating any Catalytic Bead or Infrared Combustible Monitor with a calibration gas other than Methane or Propane.

Important:

This span calibration procedure applies to most sensors. However, some sensors require a special calibration procedure.

Refer to the “Sensor Data Sheet” that came with the installed sensor for a complete list of instructions.

Equipment Needed for this Procedure: see Section 6.5: Calibration Equipment

- Sensor Data Sheet
- Magnetic Screwdriver (provided).
- SensAlert PLUS Calibration plug
- Regulator to fit bottled calibration gas (if required)
- Tubing, Tygon® for non-reactive gasses, Teflon® Tubing, for Chlorine, Ammonia, Hydrogen Chloride, Hydrogen Fluoride, Hydrogen Cyanide, Nitrogen Dioxide, Phosgene, Sulfur Dioxide, and Ethylene Oxide. (Refer to Sensor Data Sheet)
- Calibration Gas is available from Sensidyne.

Use of non-Sensidyne calibration gas is AT YOUR OWN RISK.

Note:

During calibration, the 4–20 mA signal (using factory settings) is locked at 4 mA for many sensors and 17.38 mA (20.9% Vol) for ambient Oxygen sensors.

See the Sensor Data Sheet that came with your sensor for other possible values.

1) Select OK with the magnetic screwdriver to bring up the Main Menu.

Note:

Using << anytime during the calibration is in process will cancel the calibration, return the Monitor to the Calibration Screen and restore the span calibration value. If gas is present, and a value is displayed, returning the Monitor to normal operation may create alarms.

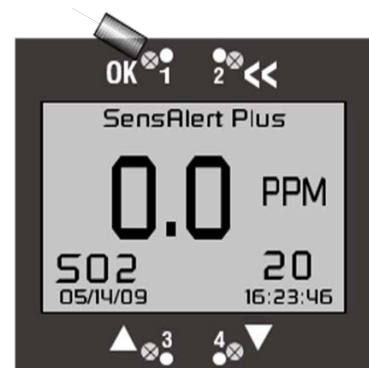

2) Select OK to bring up the Calibration Mode menu.

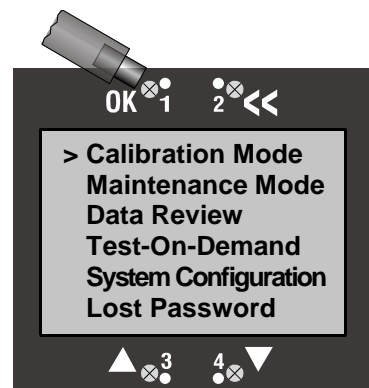

Calibration Gas Concentration Check:

Verify that the gas level used for calibration is the same as the calibration gas concentration.

In this screen, the gas concentration is shown for the last calibration. The calibration gas level shown must match the calibration gas concentration being used.

To change the Calibration Gas Concentration:

- 1) Use the ▼ arrow to move to “Set Cal Gas Conc”
- 2) Select OK.

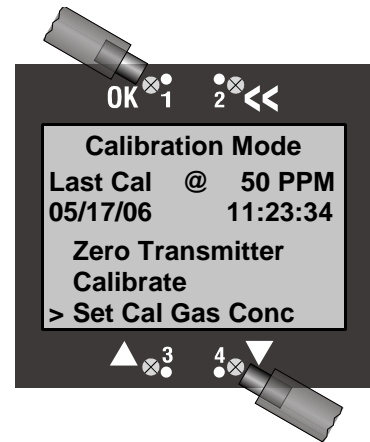

This screen displays the current calibration gas concentration.

- 3) Use the ▲ and ▼ arrows to adjust the calibration gas level to match the concentration of the calibration gas.
- 4) Select OK to set the new gas level.

The unit returns to the Calibration Mode menu after a few seconds.

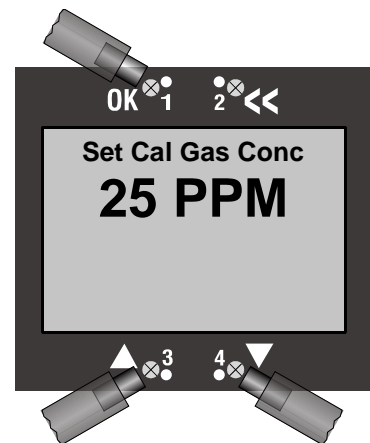

Note: Some Gases and Sensors may require pre-exposure for successful calibration.

Span Calibration:

- 1) Attach the delivery tubing from the calibration equipment to the hose connector on the calibration plug.

From the Calibration Mode Menu:

- 2) Use the ▼ arrow to move the cursor to “Calibrate.”
- 3) Select OK to begin Calibration.

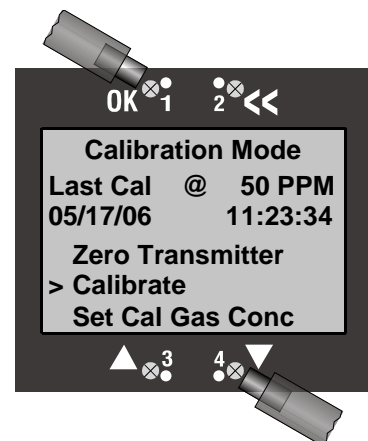

- 4) This screen indicates that the Monitor is ready for the Calibration Gas.
- 5) Begin applying the gas. (Start the regulated flow.)

The system will automatically begin calibration once the calibration gas is detected.

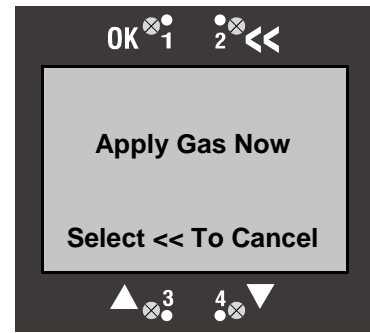

- 6) During calibration this screen will appear. Exposure times will vary depending on the gas.

The gas “Level” shown is a “live” reading. During exposure the “live” reading will increase until the gas concentration reaches stability

“Warning: exiting the calibration routine at this step may cause alarms to activate

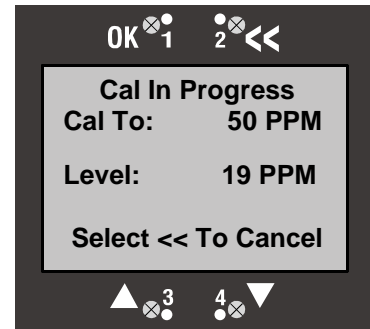

After a few moments the displayed gas level should stop changing. The system will detect that the level is stable and finish the calibration

Note: Any changes in gas level during calibration will be interpreted as instability and will cause the system to prolong the calibration procedure and even fail the calibration.

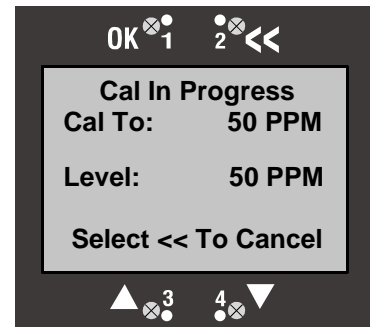

Calibration Complete:

- 1) This screen appears showing the Monitor was successfully calibrated.
- 2) Remove the calibration equipment.
- 3) Select OK

The screen will return to the Normal Operations Display when the gas level reading returns to zero.

Note: If you do not select OK after calibration and 5 minutes has elapsed, the screen automatically changes to the Normal Operations Display. Returning to the Normal Operations Display re-activates the 4 – 20 mA output.

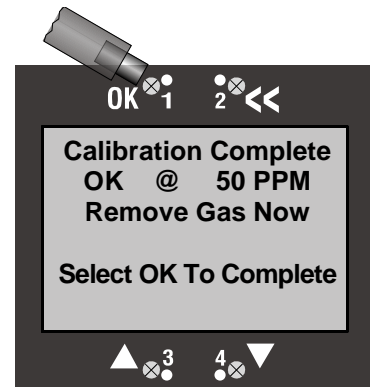

Calibration Fail:

- 1) This screen appears if the calibration was unsuccessful.
- 2) Remove the calibration equipment.
- 3) Select OK

Possible causes for failed calibration:

- Old sensor
- Unstable gas concentration
- Obstruction in gas delivery equipment

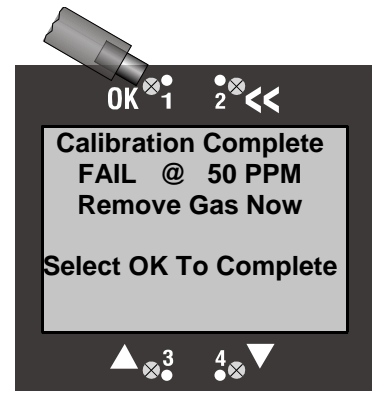

3.2 Sensor Adjustment

This section covers Sensor Adjustment for either a Catalytic Bead or Infrared Combustible sensor.

There are no adjustments possible for an Oxygen or Toxic sensor.

There are three settings in Sensor Adjustment:

- Calibration Gas Selection from a preset list.
- K-Factor Selection from a list.
- Custom K-Factor definition where the K-Factor can be manually entered.

Note about K-Factors:

A K-Factor must be entered when the target gas is different from the standard calibration gases Methane or Propane.

To gain access to the “Sensor Adjustment” control menu:

- 1) Select OK to enter the main Menu.
- 2) Use the ▼ arrow to move the cursor to “System Configuration”:
- 3) Select OK.
- 4) Use the ▼ arrow to move the cursor to “Sensor Adjustment”:

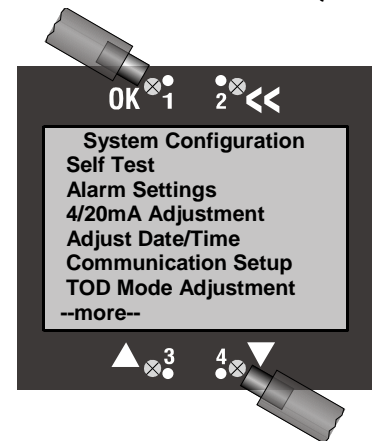
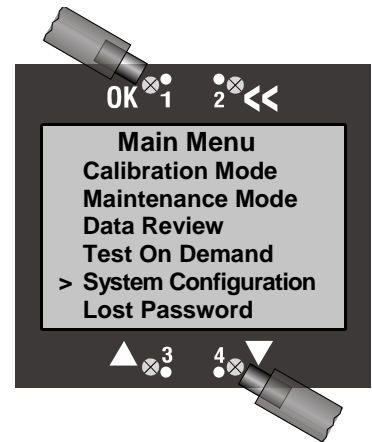

Note:

--more-- appears at the bottom when there are additional items scrolling down, at the top and bottom of the screen when in the middle of the menu and only at the top when there are additional items scrolling up.

Continued from previous note.

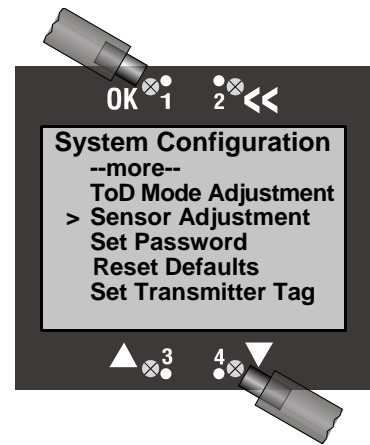

This screen will appear if an Oxygen or Toxic gas sensor is installed. No further adjustments are available through this control.

Select OK to return to the System Configuration Menu.

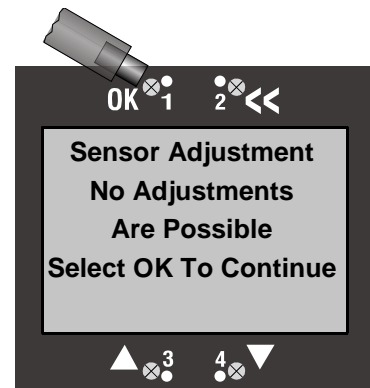

3.2.1 Select Calibration Gas

This screen will appear if sensor adjustment is allowed.

To Select Combustible Calibration Gas:

- 1) Use the ▲ and ▼ arrows to move the cursor to “Select Cal Gas”
- 2) Select OK

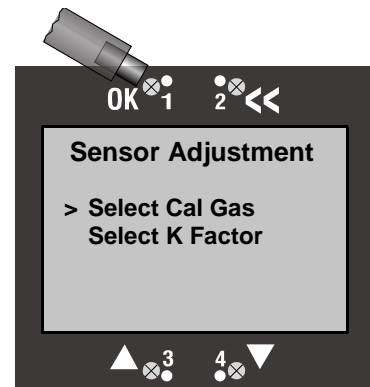

This screen appears. The cursor indicates that Methane is the current Combustible calibration gas.

There are three selections for Calibration Gases:

- Methane
- Propane
- Other

If “Other” is selected as the calibration gas then all options under the Select K-Factor menu change to either “None” (1.00) or “Custom K Factor.”

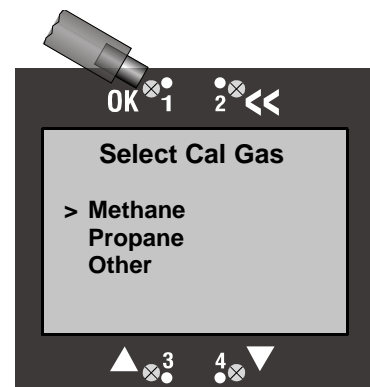

Note:

Use “Other” as the calibration gas if both the target gas and the calibration gas are the same (e.g., Butane). In this case a K-Factor of “None” would also be selected.

This screen appears if a Catalytic Bead Combustible sensor is installed.

Using << at this time will cancel this process, return the Monitor to the Select Cal Gas Screen and restore the previous Cal Gas value.

3) Select OK to save the new cal gas.

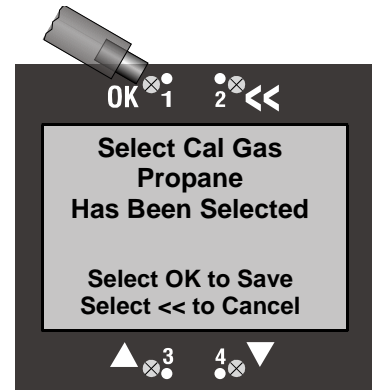

This screen appears if an Infrared Combustible sensor is installed.

Note:

The IR Combustible sensor **must** be recalibrated if the calibration gas that is selected is different from the current calibration gas. The IR Combustible sensor data will be reset and all span calibration information will be set to default values. Also, the Monitor will restart and go through “Warm Up” for the sensor.

Using << at this time will cancel this process, return the Monitor to the Select Cal Gas Screen and restore the previous Cal Gas value. It will not reset the Monitor.

4) Select OK to save the new cal gas and reset the Monitor.

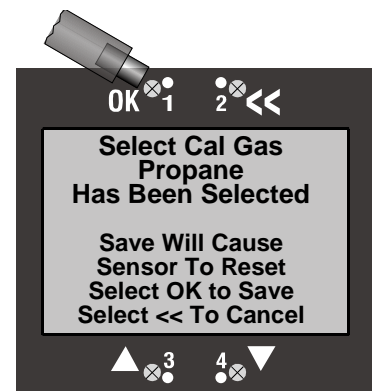

3.2.2 Selecting a K-Factor

K-Factors are used for all Combustible sensors to adjust the displayed reading when the target gas is different from the gas used to calibrate the Monitor.

For example, a Catalytic Bead Combustible sensor which is calibrated using Propane is being used to detect Hexane. In order for the displayed Hexane concentration to be accurate, a K-Factor must be applied. In this case the K-Factor for Hexane when calibrated to Propane is 1.23. Or the detected gas level is multiplied by 1.23 before being displayed.

Note:

K-Factors are not applicable when an Infrared Combustible sensor is installed and Methane is used as the calibration gas.

The examples below will show how to select a K Factor when a Catalytic Bead or Infrared Combustible sensor is installed.

K-Factor for Catalytic Bead Combustible Sensor

- 1) Ensure that a Catalytic Bead Combustible sensor is installed.
- 2) Ensure that “Methane” has been selected as the Calibration Gas. (See 3.2.1)
- 3) Gain access to the “Sensor Adjustment” control menu: (3.2.)
- 4) Use the ▲ and ▼ arrows to move the cursor to “Select K Factor”
- 5) Select OK.

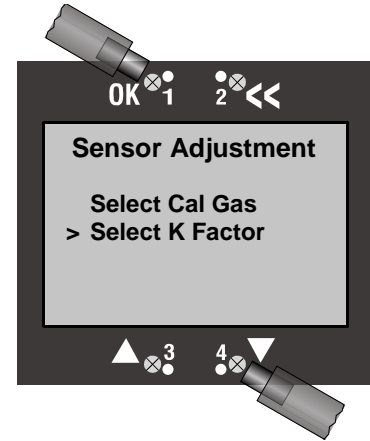

This screen appears and shows that Methane is the selected Calibration Gas. Also, it has a list of preset K-Factors along with “None” and “Custom K Factor”

Using the << anytime will exit the current routine and restore the initial setting.

- 6) Use the ▼ arrow to move the cursor to “Propane”.
- 7) Select OK.

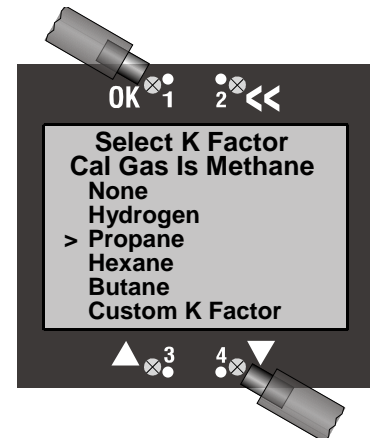

This screen appears displaying a K-Factor of 1.90 for detecting Propane when the Calibration gas is Methane.

- 8) Select OK to save the new K-Factor.

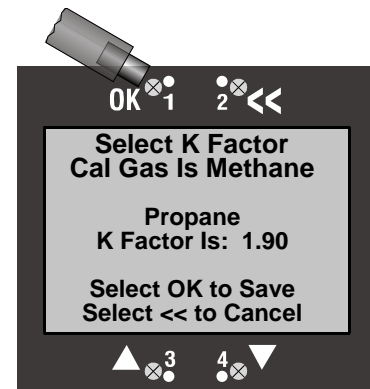
**K-Factor for Infrared Combustible Sensor**

- 1) Ensure that an Infrared Combustible sensor is installed.
- 2) Ensure that Propane has been selected as the Calibration Gas (See 3.2.1.)
- 3) Gain access to the “Sensor Adjustment” control menu: (3.2.)
- 4) Use the ▲ and ▼ arrows to move the cursor to “Select K Factor”
- 5) Select OK.

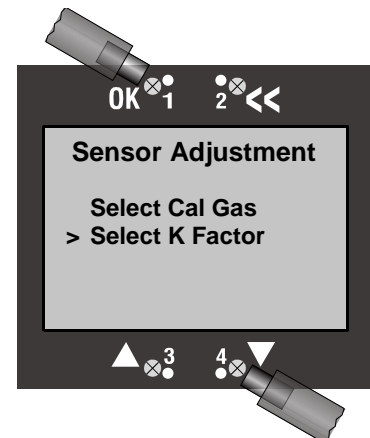

This screen appears and shows that Propane is the selected Calibration Gas. Also, it has a list of preset K-Factors along with “None” and “Custom K Factor”

Using the << anytime will exit the current routine and restore the initial setting.

6) Use the ▼ arrow to move the cursor to “Butane”.

7) Select OK.

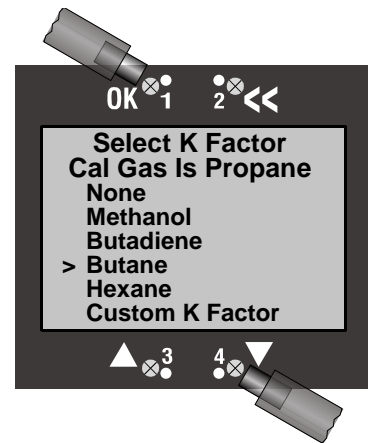

This screen appears displaying a K-Factor of 1.19 for Butane when the calibration gas is Propane.

8) Select OK to save the new K-Factor.

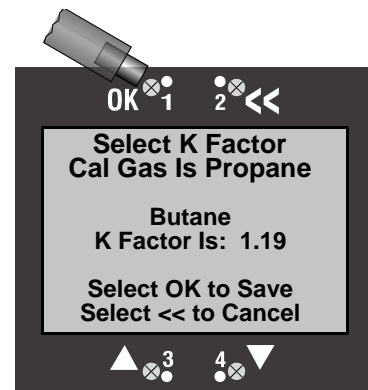

3.2.3 Selecting a Custom K-Factor

Custom K-Factors are applicable to both Catalytic Bead and Infrared Combustible Sensors and they must be applied if the target gas is not on the list of available preset K-Factors. Additional K-Factors for Catalytic Bead and Infrared Combustible sensors can be found in their respective Sensor Data sheets. Please consult Sensidyne Customer Service if a K-Factor is not on the Sensor Data sheet.

Note:

A custom K-factor is not available for Infrared Combustible sensors if the Calibration gas is Methane.

Custom K-Factor for Combustible Sensors

This example will set the K-Factor for detecting Pentane when the Sensor is calibrated with Propane. The K-Factor is 1.18 according to the sensor data sheet that came with the sensor.

- 1) Ensure that a Catalytic Bead Combustible sensor is installed.
- 2) Ensure that “Propane” has been selected as the Calibration Gas. (See 3.2.1)
- 3) Gain access to the “Sensor Adjustment” control menu: (3.2.)
- 4) Use the ▲ and ▼ arrows to move the cursor to “Select K Factor”
- 5) Select OK.

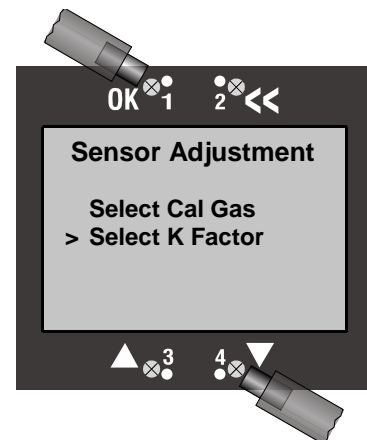

This screen appears and shows that Propane is the selected Calibration Gas. Also, it has a list of preset K-Factors along with “None” and “Custom K Factor”

Using the << anytime will exit the current routine and restore the initial setting.

6) Use the ▼ arrow to scroll to “Custom K Factor”

7) Select OK.

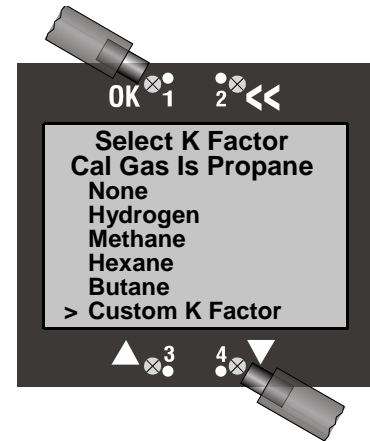

This screen appears displaying a Custom K-Factor when the Calibration gas is Propane.

8) Use the ▲ and ▼ arrows to adjust the value to 1.18.

9) Select OK to save the new Custom K-Factor.

The Monitor is now set to accurately detect Pentane when calibrated to Propane.

Use << to exit the current routine and return to the Main Display.

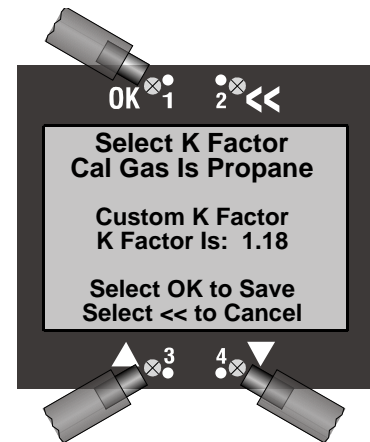

3.3 ToD Mode Adjustment

This section covers the following Test-On-Demand™ (ToD) Mode adjustment functions.

- Enable and disable the automatic testing mode
- Set the date & time for testing
- Set the number of days between tests
- Set the cell intensity,
- Designate output & fault indicators

To access the ToD Mode Adjustment Menu,

1) Select OK to display the Main Menu

2) Use the ▲ and ▼ arrows to move the cursor to “System Configuration.”

3) Select OK

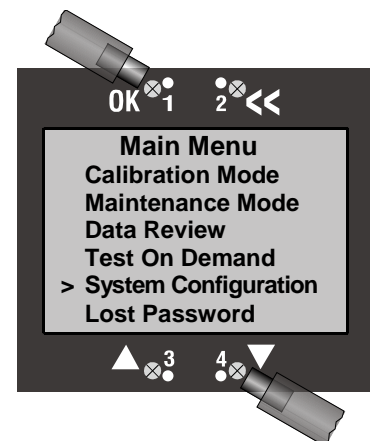

Note:

--more-- appears at the bottom when there are additional items scrolling down, at the top and bottom of the screen when in the middle of the menu and only at the top when there are additional items scrolling up.

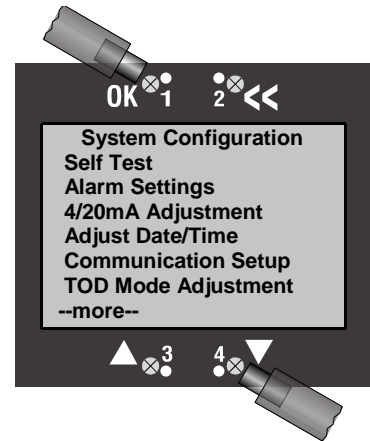

4) Use the ▲ and ▼ arrows to move the cursor to “ToD Mode Adjustment.”

5) Select OK

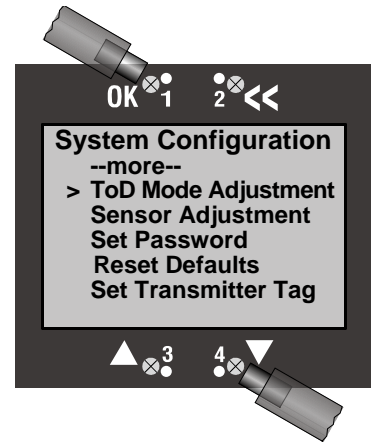

3.3.1 Auto Mode, Enable/Disable

Auto Mode Enable is a convenient way to automatically perform a Test-On-Demand at regular intervals (e.g., every 7 days).

Note:

When Test-On-Demand is performed automatically and the test fails because gas is present, system message will appear on the Normal Operation Mode Display and fault output (if enabled) will appear.

1) Use the ▲ and ▼ arrows to move the cursor to “Auto Mode Enable”

2) Select OK

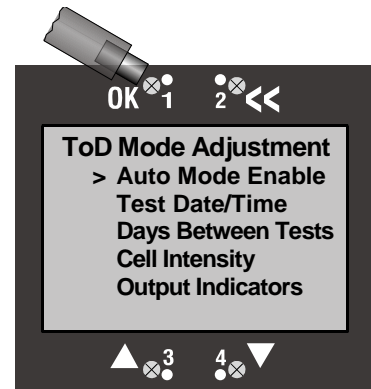

This screen appears and the cursor indicates the current setting of the Auto Mode.

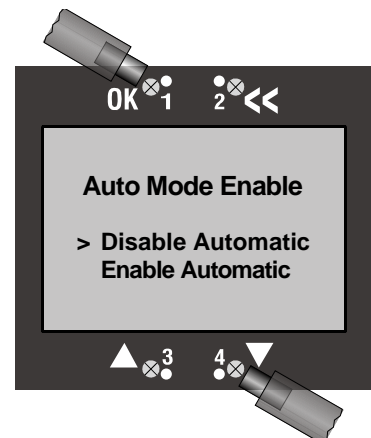

- 3) Use the ▲ and ▼ arrows to move the cursor to “Enable Automatic”
- 4) Select OK

Use << to exit the current routine and return to the Main Display.

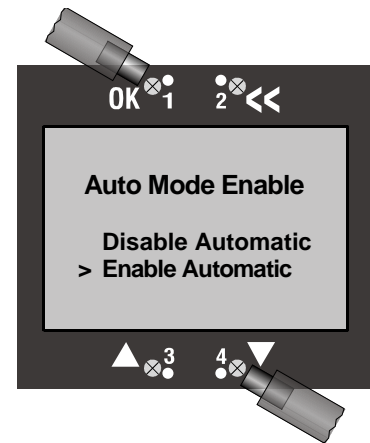

3.3.2 ToD Auto Mode, Test Date/Time

Note:

Auto mode (see 3.3.1) must be enabled before this start time for tests to occur at the date and time set in this routine. If auto enable is set after the start time has occurred, the start time will be changed to the date/time of day the auto test was enabled and will repeat at the interval set in the Days Between Tests routine.

:

To Set the Auto Test Date and Time

- 1) Select a time in the future for the ToD Auto Test
- 2) Access the ToD Mode Adjustment Menu as shown in Section 3.3
- 3) Use the ▲ and ▼ arrows to move the cursor “Test Date/Time”
- 4) Select OK.

The following sequence is for MM/DD/YY format and will be slightly different if the date format is set to DD/MM/YY.

This screen appears for the month of the test.

- 5) Use the ▲ and ▼ arrows to change the test month.
- 6) Select OK to bring up the Date screen.
- 7) Use the ▲ and ▼ arrows to change the test day of the month.
- 8) Select OK to bring up the test Year screen.
- 9) Use the ▲ and ▼ arrows to change the test Year.
- 10) Select OK to bring up the test time Hour screen.
- 11) Use the ▲ and ▼ arrows to change the Hour of day (24Hr format).
- 12) Select OK to bring up the test time Minute screen.
- 13) Use the ▲ and ▼ arrows to change the Minutes of the Hour.
- 14) Select OK to return to the ToD Mode adjustment screen.

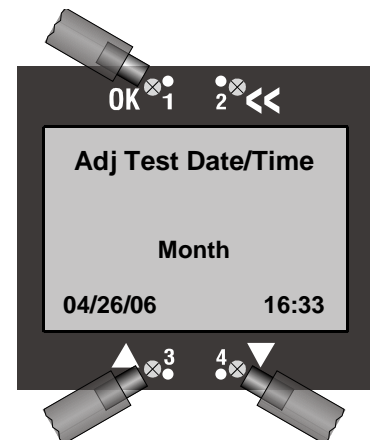
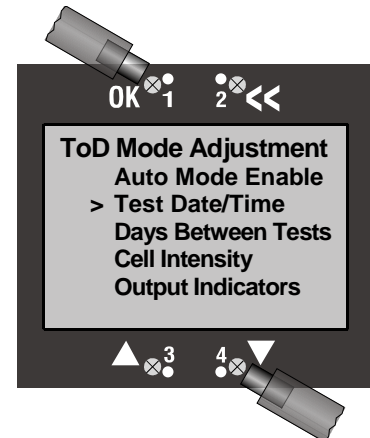

If the screen does not change back to ToD Mode Adjustment, make sure that the date or time entered is not the same or prior to the time of the Monitor system clock. The Month, Date, Year, Hour, and Minutes screens will continuously cycle until the test date/time has been changed to a date/time occurring in the future.

3.3.3 ToD Auto Mode, Days Between Tests

To Set the Auto Test, Days Between Tests:

- 1) Access the ToD Mode Adjustment Menu as shown in Section 3.3
- 2) Use the ▲ and ▼ arrows to move the cursor “Days Between Tests”
- 3) Select OK.

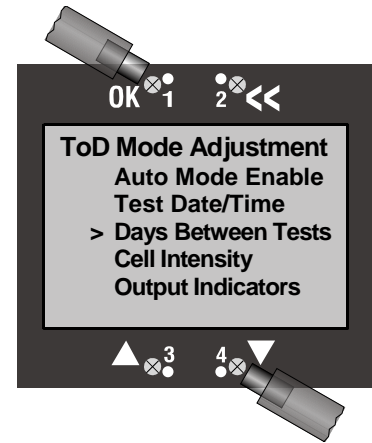

This screen appears showing the current setting for number of days between tests.

- 4) Use the ▲ and ▼ arrows to change number of days between tests.
- 5) Select OK

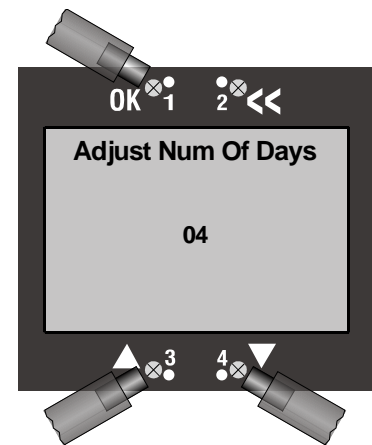

Note:

Days between tests will be in effect only when Auto Mode is enabled. Once enabled, the system will perform the ToD test on the date & time set in the Test Date/Time menu. The test will be repeated at regular intervals set here.

3.3.4 ToD Mode Adjustment, Cell Intensity

Adjusting the Intensity changes the rate that the gas is produced in the ToD Cell. Higher Intensities create stronger concentrations of gas. The factory setting is 50% and is normally adequate for most installations. However, Environmental factors such as wind or humidity may interfere with the sensors ability to detect the gas. Increasing the Intensity will overcome most of these effects.

- 1) Access the ToD Mode Adjustment Menu as shown in Section 3.3
- 2) Use the ▲ and ▼ arrows to move the cursor “Cell Intensity”
- 3) Select OK.

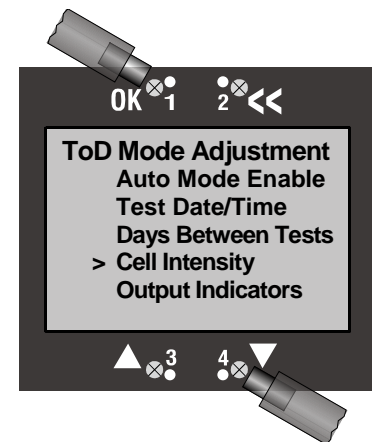

4) This screen appears showing the current cell intensity. Use the ▲ and ▼ arrows to change the cell intensity.

5) Select OK to save the new value.

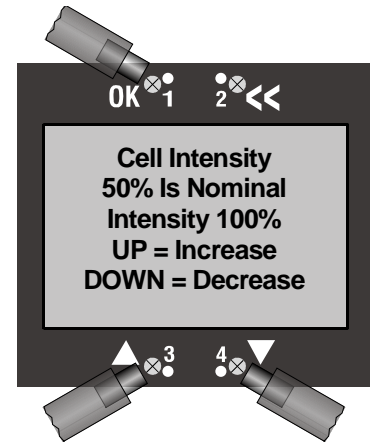

3.3.5 ToD Mode Adjustment, Output Indicators

There are “Output Indicators” that allow the Automatic Mode Test-On-Demand Activity to be monitored. Auto Mode must be enabled for this to function.

To change the Output Indicators:

1) Access the ToD Mode Adjustment Menu as shown in Section 3.3.

2) Use the ▲ and ▼ arrows to move the cursor to “Output Indicators”.

3) Select OK.

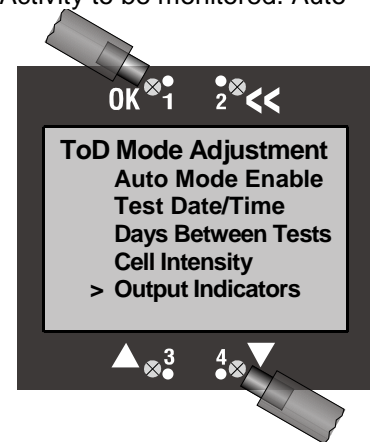

4) This screen appears showing the current output indicator, in this case “None” where the 4-20mA levels will remain at nominal baseline levels during the Auto Mode ToD Cell Test.

WARNING: In this setting the sensor output is being held low and will not respond to the actual target gas if present during the test. The 4-20mA signal loop will return to normal operation after the test finishes successfully.

Using the <<> anytime will exit the current routine and restore the initial setting.

5) Use the ▲ and ▼ arrows to move the cursor to “4-20 Current Loop”. This setting allows the 4-20mA levels to track the gas concentration during the Auto Mode ToD Cell Test.

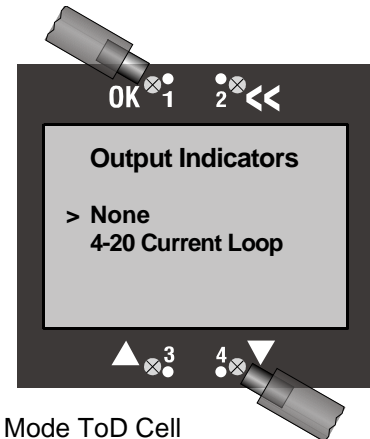

6) Select OK to save.

WARNING: In this setting the sensor output is being allowed to respond to the ToD gas level. The 4-20mA signal loop will indicate the detected concentration and return to normal operation after the test finishes successfully.

Using the <<> anytime will exit the current routine and restore the initial setting.

4 Alarms, Faults and Relays

There are 4 Alarm levels that can be configured. See section 4.1 for detailed instructions. They are.

- **Alarm 1-** The lowest level alarm also referred to as “LO” Alarm
- **Alarm 2-** The middle level alarm also referred to as “HI” Alarm
- **Alarm 3-** The highest alarm level also referred to as “HI-HI” alarm
- **TWA Alarm-** A Time **W**eighted **A**verage alarm level.
- **TWA Alarm 2-** A Time **W**eighted **A**verage alarm level.

There are 9 Faults which can be configured. See section 4.2 for detailed instructions. They are:

- **Head Fail-** Indicates the loss of communication with the Sensor Interface.
- **Missing Sensor-** Indicates loss of communication to a sensor or a Sensor is not installed.
- **Sensor Fail-** Indicates an unexpected sensor output.
- **Sensor End Of Life-** Heralds the end of a typical sensor life-span.
- **Output Current Track-** Indicates an unexpected output current.
- **Calibration Mode-** Settings for output indications during calibration.
- **Maintenance Mode-** Settings for output indications during maintenance.
- **ToD Fail-** Indicates that a Test on Demand failed to excite the sensor.
- **ToD End of Life-** Heralds the end of a typical ToD life-span.

There are 8 Relays which can be assigned to many of the alarms or faults. See section 4.3 for detailed instructions. They are:

- **Relay 1 Fail (Main PCA TB4)-** This relay is set at the factory to be normally energized and is typically used to indicate power failure at the Monitor. It can be re-associated with any Alarm or Fault.
- **Relay 2 (Main PCA TB5) -** This relay is set at the factory to be normally de-energized and can be associated with any Alarm or Fault.
- **Relay 3 (Main PCA TB6) -** This relay is set at the factory to be normally de-energized and can be associated with any Alarm or Fault.
- **Relay 4 (Main PCA TB7) -** This relay is set at the factory to be normally de-energized and can be associated with any Alarm or Fault.
- **Relay 5 (Warning Current) -** Not actually a physical relay. This indicator can only be associated with Alarms. It is used to set the 4-20mA output to the predefined output level when an associated alarm occurs.
- **Relay 6 (Horn) -** This relay is set at the factory to be normally de-energized and can be associated with any Alarm or Fault
- **Relay 7 (Red Strobe)-** This relay is set at the factory to be normally de-energized and can be associated with any Alarm or Fault
- **Relay 8 (Amber Strobe) -** This relay is set at the factory to be normally de-energized and can be associated with any Alarm or Fault

4.1 Alarms

Alarms are indications of important detected levels of the target gas. This control is used to configure setting for each alarm.

To configure an alarm:

- 1) Select OK to bring up the main menu.
- 2) Use the ▲ and ▼ arrows to move the cursor to “System Configuration”.
- 3) Select OK.

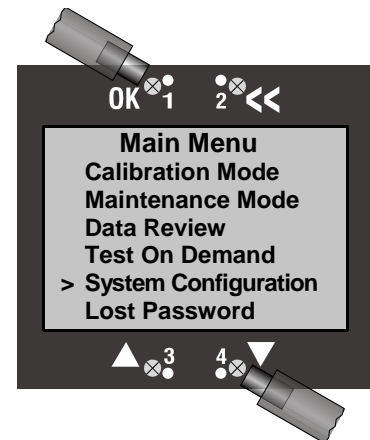

- 4) Use the ▲ and ▼ arrows to move the cursor to “Alarm Settings”.
- 5) Select OK.

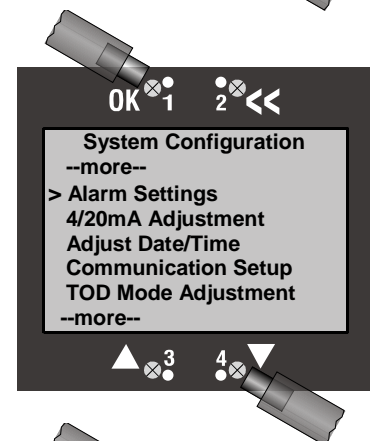

- 6) The first screen to appear should be “Alarm Functions”, if not use the ▲ and ▼ arrows to change to the “Alarm Functions” screen.
- 7) Select OK.

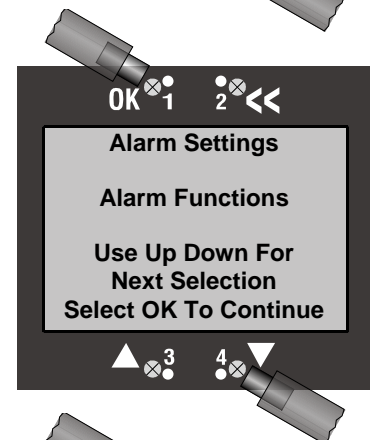

- 8) This screen appears displaying the four alarm selections. Use the ▲ and ▼ arrows to move the cursor to the desired alarms. They are:
 - **Alarm 1**- The lowest level alarm also referred to as “LO” Alarm
 - **Alarm 2**- The middle level alarm also referred to as “HI” Alarm
 - **Alarm 3**- The highest alarm level also referred to as “HI-HI” alarm
 - **TWA Alarm**- A Time Weighted Average alarm level.
 - **TWA Alarm 2**- A Time Weighted Average alarm level.

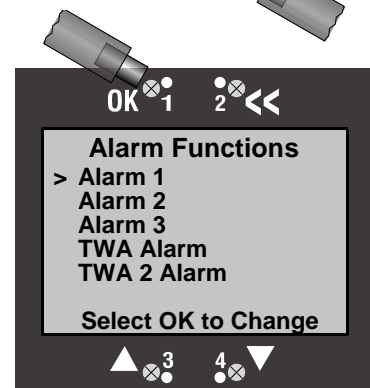

- 9) Select OK.

Alarm Configuration Screen

This screen represents the current configuration settings for each of the alarms.

The First line indicates which alarm is being set.

The second line indicates which relays are assigned to the Alarm. They appear as single digits in sequence from 1 to 8. In this case, only relay 2 has been assigned.

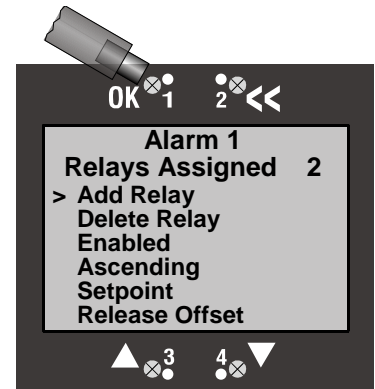

Add Relay- Assign any of the relays to the Alarm.

Delete Relay- Remove any of the relays from the Alarm.

Enabled or Disabled- The current state is shown on this screen. Enabling an alarm allows it to function. Disabling will not allow function.

Ascending or Descending- The current state is shown on this screen. Ascending alarms activate when levels rise above the set point, Descending alarms activate when levels fall below the set point. i.e. Toxic sensors are typically set to have ascending alarms whereas Ambient Oxygen Sensors are set to have Descending alarms.

Set point- This is the threshold value for the alarm to activate.

Release Offset- Not available for TWA Alarm, This is the distance from the alarm level before the alarm will reset. (If non-latching).

TWA Time Adjust- Only available for TWA Alarm. It is the time period for the average.

TWA 2 Time Adjust- Only available for TWA Alarm. It is the time period for the average.

4.1.1 Add a Relay

- 1) Use the ▲ and ▼ arrows to move the cursor to “Add Relay”.
- 2) Select OK.
- 3) Use the ▲ and ▼ arrows to change the screens until the desired Relay is displayed.

Sequence of Screens and Relays available:

- Relay 1 – Fail
- Relay 2
- Relay 3
- Relay 4
- Warn Current – Relay 5
- Horn – Relay 6
- Red Strobe – Relay 7
- Amber Strobe – Relay 8

- 4) For this example, pick relay 3.
- 5) Select OK to add the relay.

Line 2 on this screen shows that Relay 3 has been added.

- 6) When finished adding relays select << to return to the Alarm menu screen.

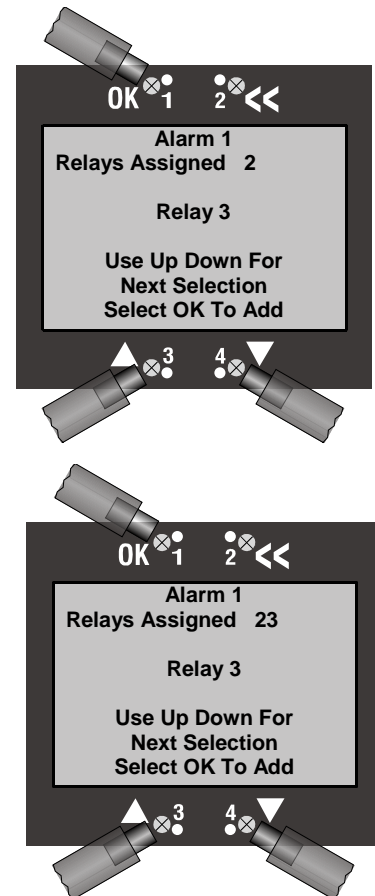

4.1.2 Delete a Relay

- 1) Use the ▲ and ▼ arrows to move the cursor to “Delete Relay”.
- 2) Select OK.

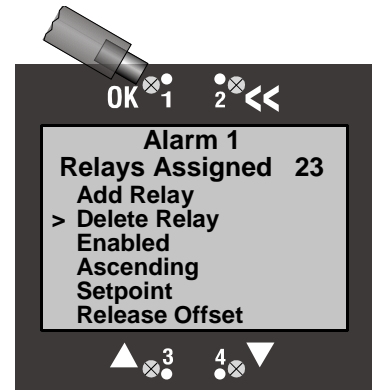

- 3) To Delete a Relay. Use the ▲ and ▼ arrows to change the screens until the desired Relay is displayed.

Sequence of Screens and Relays available:

- Relay 1 – Fail
- Relay 2
- Relay 3
- Relay 4
- Warn Current – Relay 5
- Horn – Relay 6
- Red Strobe – Relay 7
- Amber Strobe – Relay 8

- 4) For this example, pick relay 3.
- 5) Select OK to delete the relay.

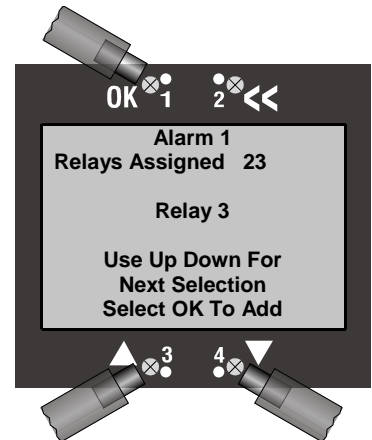

Line 2 on this screen shows that Relay 3 has been deleted.

- 6) When finished deleting relays select << to return to the Alarm menu screen.

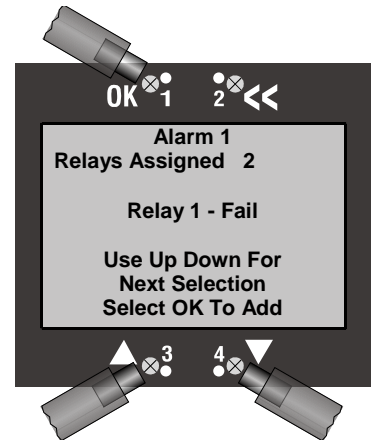

4.1.3 Enable or Disable an Alarm

The current state is shown on this screen. Enabling an alarm allows it to function. Disabling will not allow function.

- 1) Use the ▲ and ▼ arrows to move the cursor to “Enabled or Disabled”
- 2) Select OK.

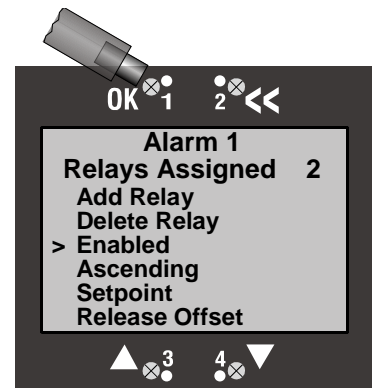

3) To change and save the state to the displayed setting, Select OK.

Using the << anytime will exit the current routine and restore the initial setting.

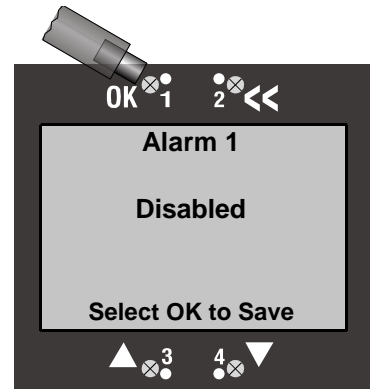

4.1.4 Ascending or Descending alarm threshold

The current state is shown on this screen. Ascending alarms activate when levels rise above the set point, Descending alarms activate when levels fall below the set point. i.e. Toxic sensors are typically set to have ascending alarms whereas Ambient Oxygen Sensors are set to have Descending alarms.

- 1) Use the ▲ and ▼ arrows to move the cursor to “Ascending or Descending”
- 2) Select OK.

Using the << anytime will exit the current routine and restore the initial setting.

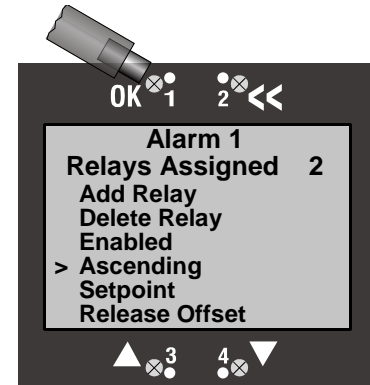

3) To change and save the state to the displayed setting, Select OK.

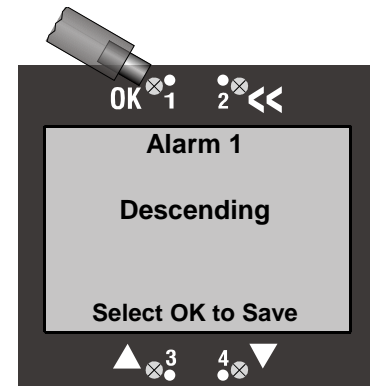

4.1.5 Alarm Setpoint

The alarm set point is the threshold value for the alarm to activate.

- 1) Use the ▲ and ▼ arrows to move the cursor to “Setpoint”
- 2) Select OK.

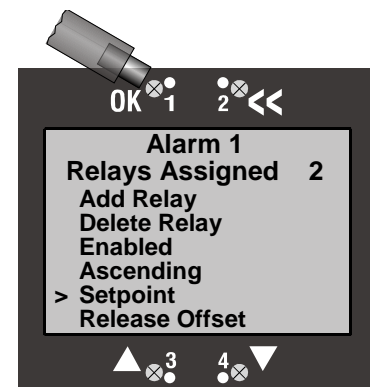

This screen displays the current set point in units detected.

- 3) Use the ▲ and ▼ arrows to change the value of the alarm set point in units detected.

Using the << anytime will exit the current routine and restore the initial setting.”

- 4) Select OK to save the new set point.

Note: *Combustible Sensors cannot be set below 10% or above 60% full-scale value. Toxic sensors cannot be set below 10% full-scale value.*

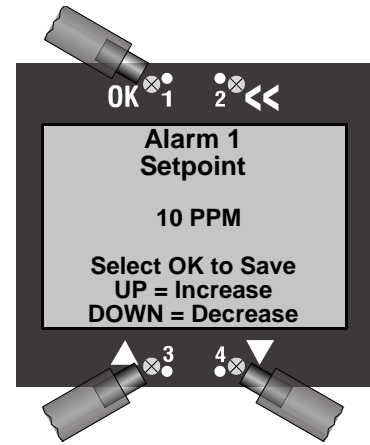

4.1.6 Release Offset

The Release Offset applies to Alarms 1, 2 and 3 only.

The release offset is the level the displayed amount must differ from the set point for the alarm to reset (if non-latching). For ascending alarms it is a value below the set point, for descending alarms it is a value above the set point.

- 1) Use the ▲ and ▼ arrows to move the cursor to “Release Offset”
- 2) Select OK.

This screen displays the current release offset in units detected.

- 3) Use the ▲ and ▼ arrows to change the value of the release offset.

Using the << anytime will exit the current routine and restore the initial setting.”

- 4) Select OK to save the new value.

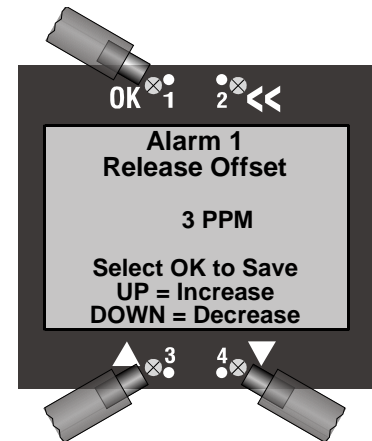
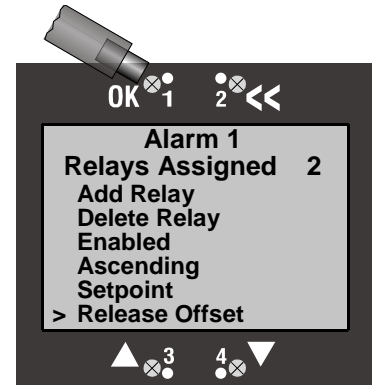

4.1.7 TWA Average Time Adjustment

The Time Weighted Average alarm has the majority of configuration settings found on alarms 1, 2 and 3. It does not have a release offset adjustment. Instead, it has an Average Time Adjustment. For this alarm, the time period used for the average can be set to one of six preset values.

To adjust the Average Time:

- 1) Access the Alarm Function menu described in 4.1
- 2) Use the ▲ and ▼ arrows to move the cursor to “TWA Alarm”.
- 3) Select OK.

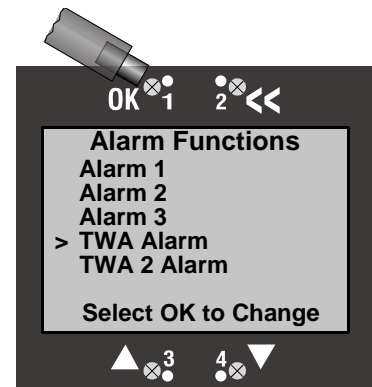

- 4) Use the ▲ and ▼ arrows to move the cursor to "Average Time Adjust".
- 5) Select OK.

This screen shows the available time periods and the cursor adjacent to the current setting.

- 6) Use the ▲ and ▼ arrows to move the cursor to the new desired time period.

15 Minutes, 30 Minutes, 60 Minutes, 2 Hours, 4 Hours or 8 Hours

Using the << anytime will exit the current routine and restore the initial setting.

- 7) Select OK to save the new setting.

Note: The TWA 2 Alarm provides different time selections for 0.5, 1, 2, 5, 10, and 20 minutes.

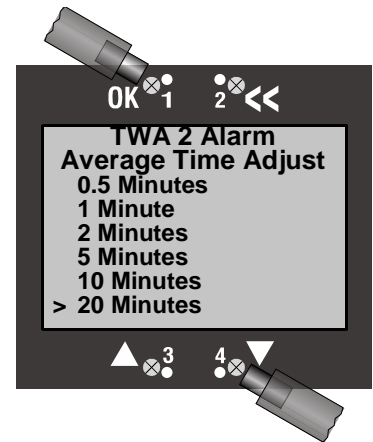
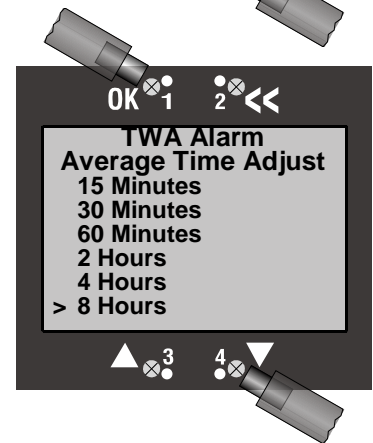
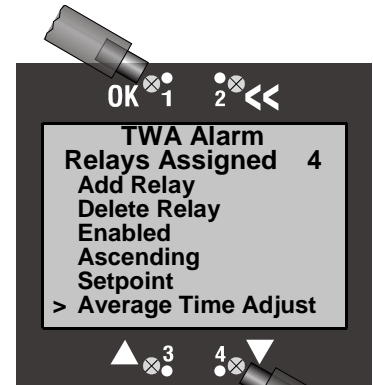

4.2 Fault Functions

The SensAlarm PLUS control system is constantly assessing the internal operation of the Monitor. Several critical functions are monitored constantly and can be assigned an indicator to announce the occurrence of a system fault.

To configure a fault:

- 1) Select **OK** to bring up the main menu.
- 2) Use the ▲ and ▼ arrows to move the cursor to "System Configuration".
- 3) Select **OK**.
- 4) Use the ▲ and ▼ arrows to move the cursor to "Fault Functions".
- 5) Select **OK**.

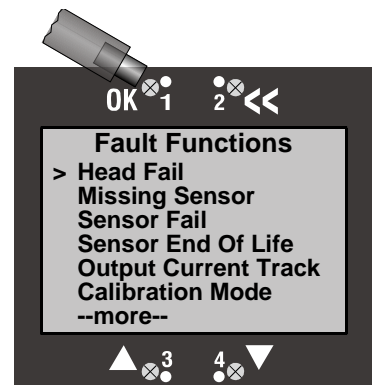

There are 9 Faults which can be configured using this control. They are:

1. **Head Fail-** Indicates the loss of communication with the Sensor Interface. Factory assigned to "Relay 1 – Fail"
2. **Missing Sensor-** Indicates loss of communication to a sensor or a sensor is not installed. Factory assigned to "Relay 1 – Fail"
3. **Sensor Fail-** Indicates an unexpected sensor output. Factory assigned to "Relay 1 – Fail"
4. **Sensor End Of Life-** Heralds the end of a typical sensor life-span. Not assigned to any relays at the factory.
5. **Output Current Track-** Indicates an unexpected output current. Not assigned to any relays at the factory.
6. **Calibration Mode-** Settings for output indications during calibration. Assigned Relays will transition during Calibration when enabled. Not assigned to any relays at the factory.
7. **Maintenance Mode-** Settings for output indications during maintenance. Assigned Relays will transition during Maintenance Mode when enabled. Not assigned to any relays at the factory
8. **ToD Fail-** Indicates that a Test on Demand failed to excite the sensor. Not assigned to any relays at the factory.
9. **ToD End of Life-** Heralds the end of a typical ToD life-span. Not assigned to any relays at the factory.

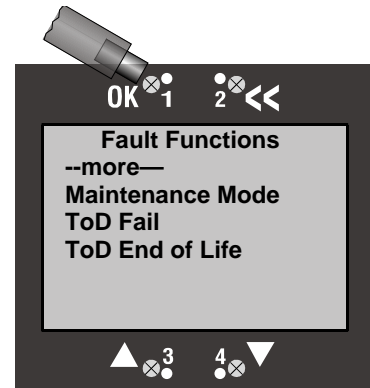

Fault Configuration Screen

This screen represents the current configuration settings for each of the faults.

The First line indicates which fault is being set.

The second line indicates which relays are assigned to the Fault. They appear as single digits in sequence from 1 to 8. In this case, only relay 1 has been assigned.

Add Relay- Assign any of the relays to the Fault.

Delete Relay- Remove any of the relays from the Fault.

Enabled or Disabled- The current state is shown on this screen. Enabling a fault allows it to function. Disabling will not allow function.

Adj Fault Current - The fault current is a specific 4-20 signal between 1 and 4mA. Each Fault can be assigned a separate current level allowing remote identification of the specific fault. If multiple faults occur, only the lowest current value is indicated.

Adj Current Delay- The current delay is a time setting for the low current output of the fault from 1 to 240 seconds. (Only available on Sensor End of Life, Output Current Track, ToD Fail and ToD End of Life).

4.2.1 Add a Relay

Refer to section 4.1.1 for adding relays to faults. (Relay 5 Warning Current is not available for system faults. It is actually the fault current.)

Sequence of Screens and Relays available:

- Relay 1 – Fail
- Relay 2
- Relay 3
- Relay 4
- Horn – Relay 6
- Red Strobe – Relay 7
- Amber Strobe – Relay 8

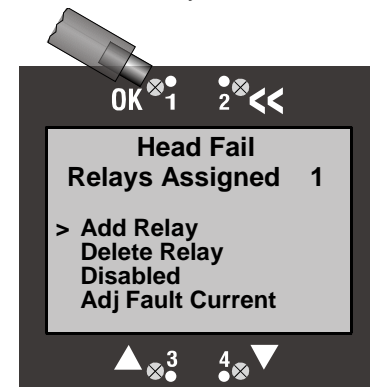

4.2.2 Delete a Relay

Refer to section 4.1.2 for deleting relays from faults. (Relay 5 Warning Current is not available for system faults. It is actually the fault current.)

Sequence of Screens and Relays available:

Relay 1 – Fail
 Relay 2
 Relay 3
 Relay 4
 Horn – Relay 6
 Red Strobe – Relay 7
 Amber Strobe – Relay 8

4.2.3 Enable or Disable a Fault

Refer to section 4.1.3 for enabling or disabling a fault. The current state is shown on the Fault Configuration screen. Enabling allows the fault to function normally and activate the associated configuration settings. Disabling the Fault does not allow function even if the system fault occurs.

4.2.4 Adjust Fault Current

The Fault Current for each Fault Function can be individually set between 1 and 4mA at 0.05mA steps.

NOTE: If multiple Faults occur, the Fault with lowest current setting takes precedence.

For this example The Head Fail Fault Current will be adjusted to 2.30mA

- 1) Gain access to the first Head Fail, Fault Function screen.
- 2) Use the ▼ arrow to move the cursor to “Adj Fault Current”. Select OK.
- 3) This screen appears showing the present Fault Current Value. Use the ▲ and ▼ arrows to adjust the fault current in 0.05 mA steps to be 2.30.
- Using the << anytime will exit the current routine and restore the initial setting.
- 4) Select OK to save the new value

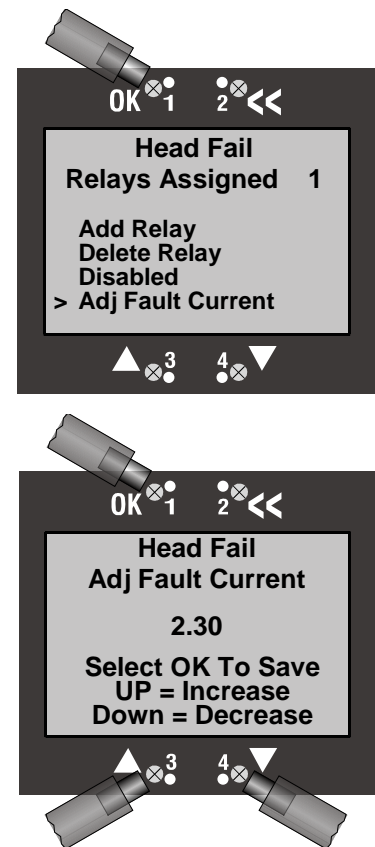

4.2.5 Adjust Fault Current Delay

Only available for the following Fault Functions:

- 1) Sensor End of Life
- 2) Output Current Track
- 3) ToD Fail
- 4) ToD End of Life.

The Adjust Current Delay routine is used to change the fault current delay for the specific Fault Function. The Delay can be set from 0 to 300 seconds. In this example, The Sensor End Of Life, Fault Function, Current Delay will be set to 15 Seconds. When a Sensor End of Life fault occurs the 4-20mA output current will drop to the specified current level for 15 seconds each hour until the Fault is cleared.

- 1) Gain access to the Sensor End Of Life Fault Function screen.
- 2) Use the ▼ arrow to move the cursor to “Adj Current Delay” and select OK

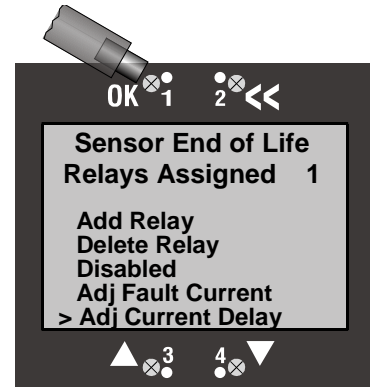

- 3) This screen appears showing the present Current Delay Value for the displayed fault. Use the ▲ and ▼ arrows to adjust the fault current in 1 second steps to be 15. When finished adjusting the value select OK to save the new value.

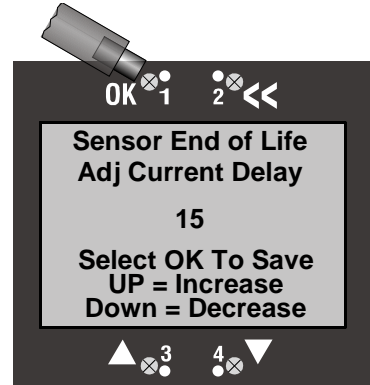

4.3 Warn Current – Relay 5

The Warn Current-Relay 5 is a warning function that drops the 4-20 mA output to the Fault Current Level when an assigned alarm condition occurs. It does not actually have a mechanical relay.

- 1) Follow [Section 4.1](#) steps 1 through 5.
- 2) Use the ▲ and ▼ arrows to change to the “Warn Current-Relay5” screen.
- 3) Select **OK**.

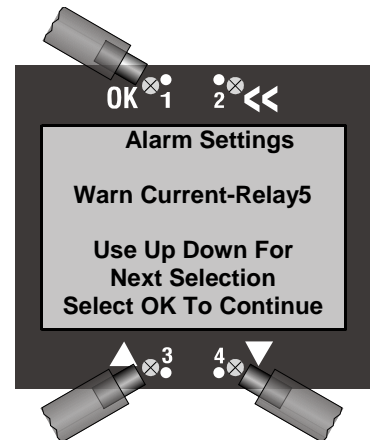

4.3.1 Warn Current-Relay 5, Latching/Non-Latching

The latching feature causes the warning to persist after the alarm condition has subsided. Latched warnings must be reset manually.

- 1) Access the Warn Current – Relay 5 Menu

The following screen has the current state displayed.

Notice that the cursor is indicating that Non-Latching is selected.

- 2) Select **OK**.

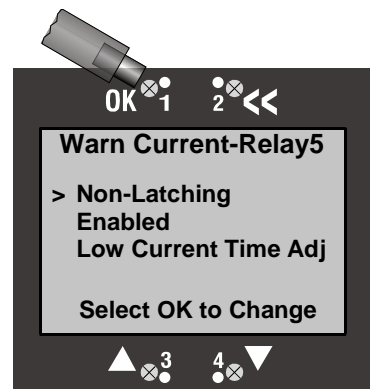

This screen shows that the Warn Current-Relay 5 will be changed to Latching.

3) To change the status, select OK.

“Latching” should be in the list of options the next time the Warn Current Relay 5 Menu is accessed.

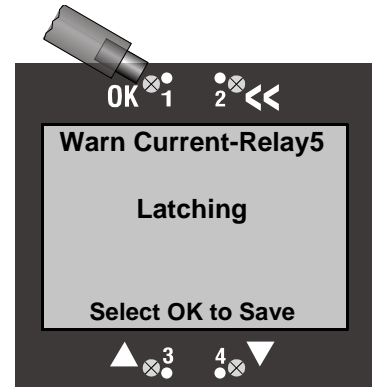

4.3.2 Warn Current – Relay 5, Enable or Disable

To Enable or Disable the Warning Current:

1) Access the Warn Current – Relay 5 Menu.

The following screen will be displayed. Notice that the cursor is indicating that Disabled is selected.

2) Use the ▼ arrow to move the cursor to Either Disabled or Enabled (depending on the current state of the relay).

3) Select OK.

Note: Using the << anytime will exit the current routine and restore the initial setting.”

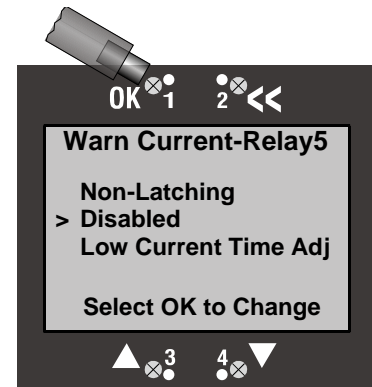

This screen shows that the Warn Current-Relay 5 will be changed to “Enabled”

4) To change the status, select OK.

“Enabled” should be in the list of options the next time the Warn Current Relay 5 Menu is accessed.

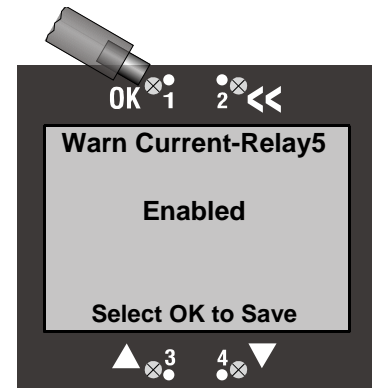

4.3.3 Low Current Time Adjust

The Low Current Time Adjust refers to the amount of time the Warn Current Adjust-Relay 5 remains at the Fault Current level when an Alarm condition occurs. The time delay can be set at one second intervals between 1 and 240 Seconds.

1) To adjust the Low Current Time Delay, use the ▼ arrow to move the cursor to “Low Current Time Adj”

2) Select OK.

Note: Using the << anytime will exit the current routine and restore the initial setting.

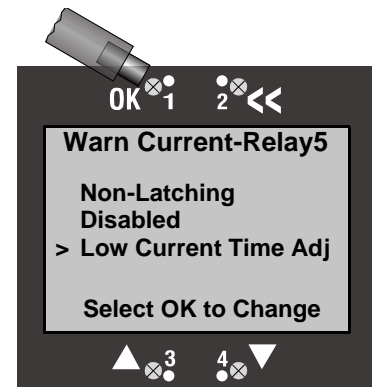

- 3) This screen appears showing the present Low Output Current Time Delay. Use the ▲ and ▼ arrows to adjust the time delay.
- 4) When finished select **OK** to save the new value.

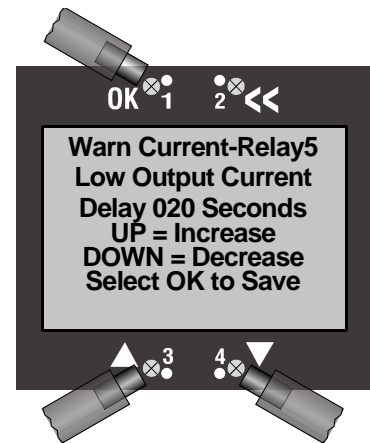

4.4 Relay 1-Fail, Relay 2, Relay 3, Relay 4

The following settings apply to all four of the mechanical Relays:

- Latching/Non-latching
- Energized/De-Energized
- Time Delay

Relay 1 - Fail is set at the factory to be non-latching, normally energized with a time delay of 10 seconds. All other relays are set at the factory to be non-latching, normally de-energized with a time delay of 10 seconds.

The following example is for Relay1 – Fail, and is applicable for all other Relays.

- 1) Follow [Section 4.1](#) steps 1 through 5.
- 2) Use the ▲ and ▼ arrows to change to the “Relay 1 - Fail” screen.
- 3) Select **OK**.

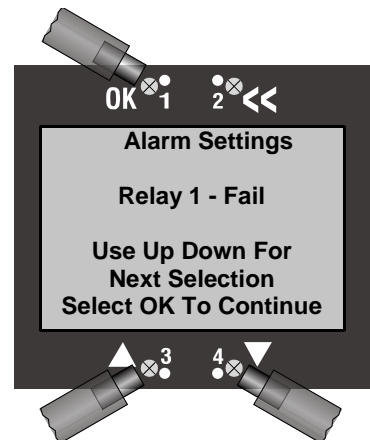

4.4.1 Latching or Non-Latching

The latching feature causes the warning to persist after the alarm condition has subsided. This is indicated when the LED associated with the “latched” relay remains lit. The relay must be manually deactivated (reset) by selecting << from the Normal Operation Display screen or Red reset switch located at the bottom on the enclosure.

A non-latching relay will automatically reset (deactivate) when the condition no longer exists.

- 1) This screen shows that Relay 1 is currently Non-Latching. To change the status, make sure that the cursor is at Non-Latching (or Latching). If not use the ▲ and ▼ arrows move the cursor to indicate Non-Latching (or Latching)
- 2) Select **OK**.

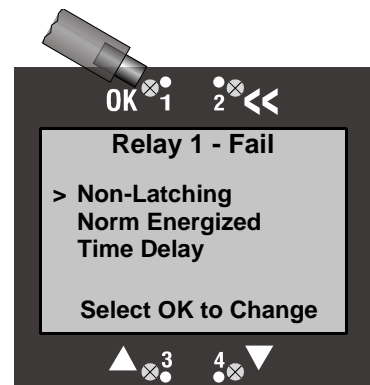

Note: Using the << anytime will exit the current routine and restore the initial setting.

- 3) This screen appears showing that Relay 1 is now Latching.
- 4) Select OK to save the change.

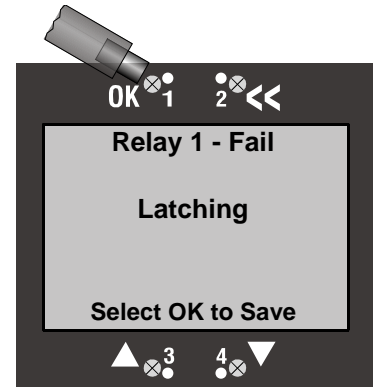

4.4.2 Norm Energized/ Norm De-Energized

This feature sets the relay to be either Normally Energized or Normally De-Energized. Relay1-Fail is set from the factory to be Normally Energized which causes it to change state when power is removed from the monitor. All other Relays are factory set to be Normally De-Energized and they do not change state when power is removed from the Monitor.

This screen shows that Relay 1 is currently Normally Energized.

To change the status:

- 1) Make sure that the cursor is at Norm Energized (or De-Energized). If not use the ▲ and ▼ arrows move the cursor to indicate Norm Energized (or De-Energized).
- 2) Select OK.

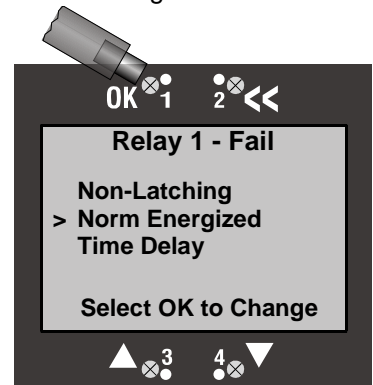

Note: Using the << anytime will exit the current routine and restore the initial setting.

- 3) This screen appears showing that Relay 1 is now Norm Energized (or De-Energized).

Note: Using the << anytime will exit the current routine and restore the initial setting.

- 4) Select OK to save the change.

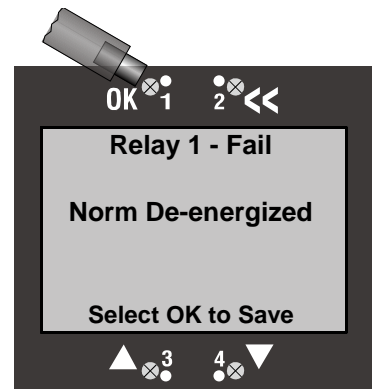

4.4.3 Time Delay

The time delay is the amount of time that the relay activation is delayed after the initiation of either an alarm or fault. It can be set from 1 to 240 seconds. A time delay is typically set when the user does not want the relay to activate external strobes or horns for intermittent, transient gas spikes at lower concentrations.

To adjust the Time Delay:

- 1) Access the relay settings screen.
- 2) Make sure that the cursor is at "Time Delay". If not use the ▲ and ▼ arrows to move the cursor
- 3) Select **OK**.

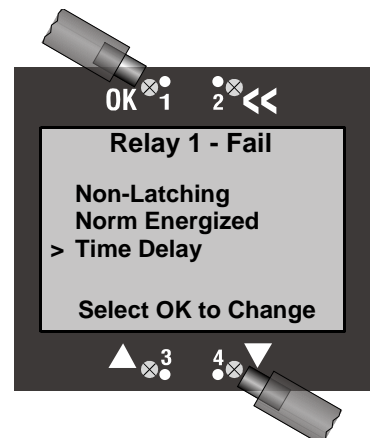

This screen shows the current setting.

4) Use the ▲ and ▼ arrows to change the value of the time delay.

Note: Using the << anytime will exit the current routine and restore the initial setting.

5) Select **OK** to save the new setting.

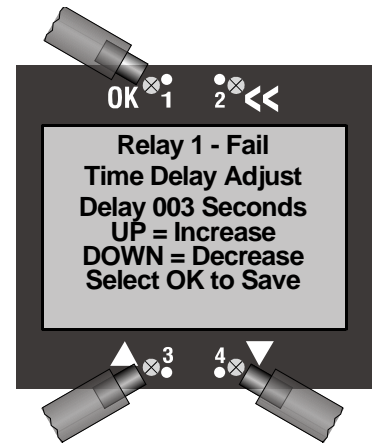

4.5 Horn – Relay 6

The Internal Horn (or sounder) is located on the bottom of the enclosure. The sounder can be silenced with a red pushbutton switch. The alarm reset conforms to ISA alarm sequence 3A. The available configuration settings are:

- Latching/Non-latching
- Timeout (Enabled/Disabled)
- Time Delay
- Timeout Delay

Relay 6 Horn is set at the factory to be non-latching, Timeout disabled, time delay of 10 seconds, and the Timeout delay at 240 seconds.

- 1) Follow [Section 4.1](#) steps 1 through 5.
- 2) Use the ▲ and ▼ arrows to change to the “Horn – Relay 6” screen.
- 3) Select **OK**.

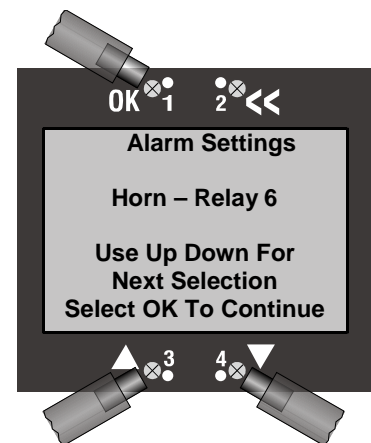

4.5.1 Latching or Non-Latching

The latching feature causes the warning to persist after the alarm condition has subsided. The horn must be manually deactivated (reset) by selecting << from the Normal Operation Display screen or Red reset switch located at the bottom on the enclosure.

A non-latching horn will automatically reset (deactivate) when the condition no longer exists.

- 1) This screen shows that Horn is currently Non-Latching. To change the status, make sure that the cursor is at Non-Latching (or Latching). If not use the ▲ and ▼ arrows move the cursor to indicate Non-Latching (or Latching)
- 2) Select **OK**.

Note: Using the << anytime will exit the current routine and restore the initial setting.

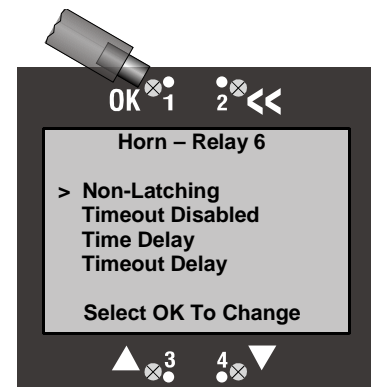

- 3) This screen appears showing that Horn is now Latching.
- 4) Select **OK** to save the change.

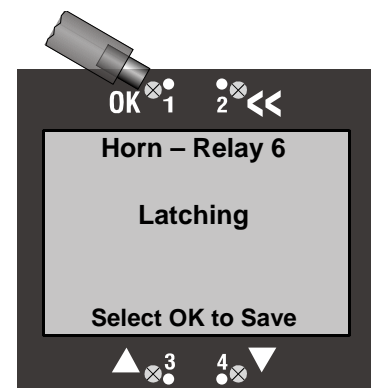

4.5.2 Timeout (Enabled/Disabled)

The timeout feature causes the Horn to silence after a predetermined time set in the Timeout Delay menu. The alarm condition has to subside to reset the timeout.

- 1) This screen shows that the Horn timeout is currently disabled. To change the status, make sure that the cursor is at Timeout Disabled (or Timeout Enabled). If not use the ▲ and ▼ arrows move the cursor to indicate Timeout Disabled (or Timeout Enabled).
- 2) Select OK.

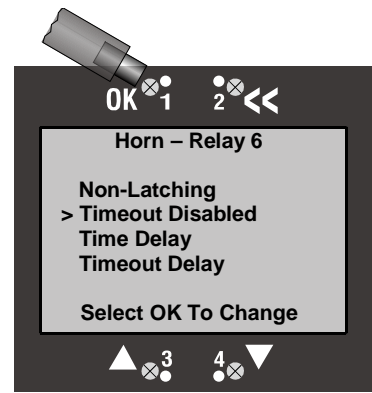

Note: Using the << anytime will exit the current routine and restore the initial setting.

- 3) This screen appears showing that the Horn timeout is enabled.
- 4) Select OK to save the change.

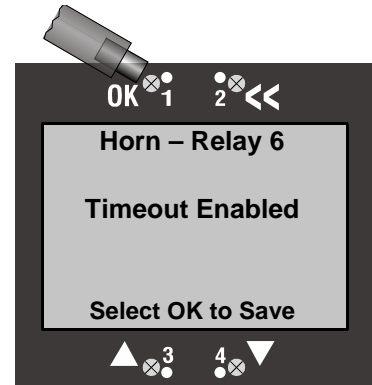

4.5.3 Time Delay

The time delay is the amount of time that the horn activation is delayed after the initiation of an assigned alarm or fault. It can be set from 1 to 240 seconds.

To adjust the Time Delay:

- 1) Access the relay settings screen.
- 2) Make sure that the cursor is at "Time Delay". If not use the ▲ and ▼ arrows to move the cursor
- 3) Select **OK**.

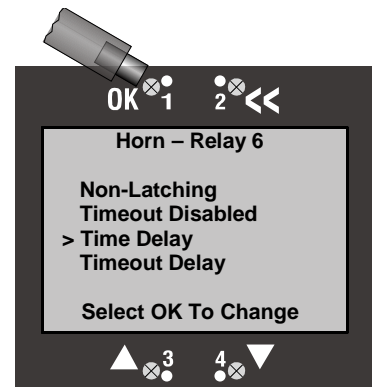

This screen shows the current setting.

- 4) Use the ▲ and ▼ arrows to change the value of the time delay.

Note: Using the << anytime will exit the current routine and restore the initial setting.

- 5) Select **OK** to save the new setting.

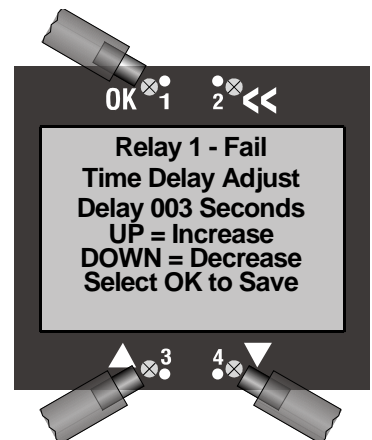

4.5.4 Timeout Delay

The Timeout Delay is the amount of time that the horn is active if Timeout is enabled after the initiation of an assigned alarm or fault. It can be set from 1 to 240 seconds.

To adjust the Time Delay:

- 1) Access the relay settings screen.
- 2) Make sure that the cursor is at "Timeout Delay". If not use the ▲ and ▼ arrows to move the cursor
- 3) Select **OK**.

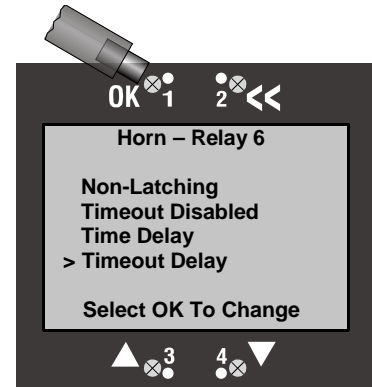

This screen shows the current setting.

- 4) Use the ▲ and ▼ arrows to change the value of the time delay.

Note: Using the << anytime will exit the current routine and restore the initial setting."

- 5) Select **OK** to save the new setting.

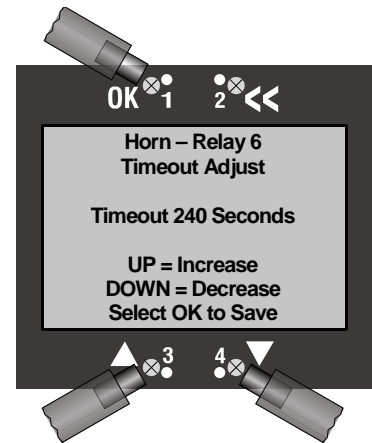

4.6 Red Strobe - Relay7, Amber Strobe-Relay8

The following settings apply to both the Red Strobe and optional Amber Strobe

- Latching/Non-latching
- Energized/De-Energized
- Time Delay

Red Strobe and optional Amber Strobe are set at the factory to be non-latching, normally de-energized with a time delay of 10 seconds.

The following example is for Red Strobe – Relay7, and is applicable to the Amber Strobe.

- 1) Follow [Section 4.1](#) steps 1 through 5.
- 2) Use the ▲ and ▼ arrows to change to the "Red Strobe – Relay7" screen.
- 3) Select **OK**.

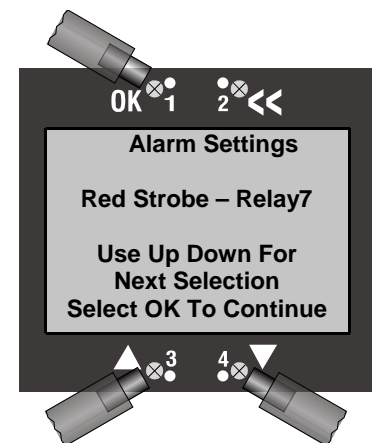

4.6.1 Latching or Non-Latching

The latching feature causes the warning to persist after the alarm condition has subsided. The strobe must be manually deactivated (reset) by selecting << from the Normal Operation Display screen or pressing the Red reset switch located at the bottom on the enclosure.

A non-latching strobe will automatically reset (deactivate) when the condition no longer exists.

- 1) This screen shows that the Red Strobe is currently Non-Latching. To change the status, make sure that the cursor is at Non-Latching (or Latching). If not use the ▲ and ▼ arrows move the cursor to indicate Non-Latching (or Latching)
- 2) Select OK.

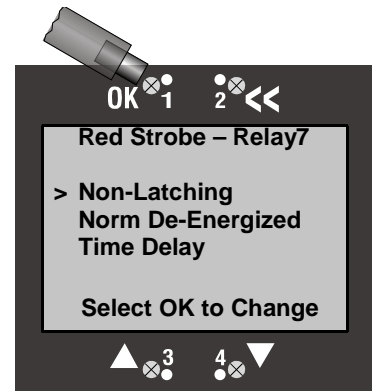

Note: Using the << anytime will exit the current routine and restore the initial setting.

- 3) This screen appears showing that Relay 1 is now Latching.
- 4) Select OK to save the change.

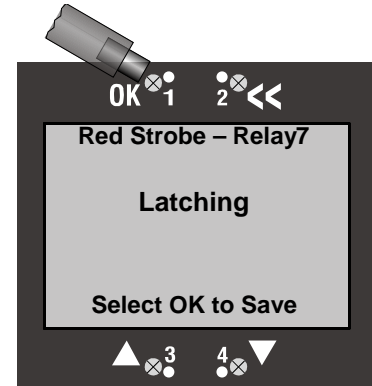

4.6.2 Norm Energized/ Norm De-Energized

This feature sets the strobe to be either Normally Energized (On) or Normally De-Energized (Off). Strobes are factory set to be Normally De-Energized (Off).

To change the status:

- 1) Make sure that the cursor is at Norm De-Energized (or Energized). If not use the ▲ and ▼ arrows move the cursor to indicate Norm De-Energized (or Energized).
- 2) Select OK.

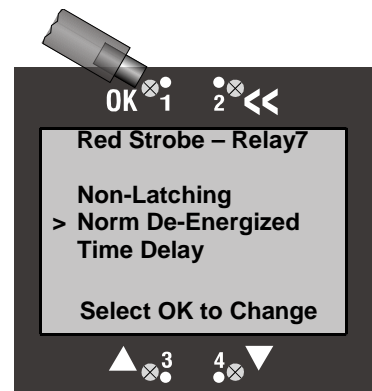

Note: Using the << anytime will exit the current routine and restore the initial setting.

- 3) This screen appears showing that Relay 1 is now Norm Energized (or De-Energized).

Note: Using the << anytime will exit the current routine and restore the initial setting.

- 4) Select OK to save the change.

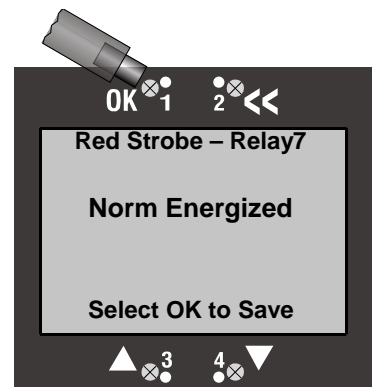

4.6.3 Time Delay

The time delay is the amount of time that the strobe activation is delayed after the initiation of either an assigned alarm or fault. It can be set from 1 to 240 seconds. A time delay is typically set when the user does not want the strobe to activate for intermittent, transient gas spikes at lower concentrations.

To adjust the Time Delay:

- 1) Access the strobe settings screen.
- 2) Make sure that the cursor is at "Time Delay". If not use the ▲ and ▼ arrows to move the cursor
- 3) Select **OK**.

This screen shows the current setting.

- 4) Use the ▲ and ▼ arrows to change the value of the time delay.

Note: Using the << anytime will exit the current routine and restore the initial setting.

- 5) Select **OK** to save the new setting.

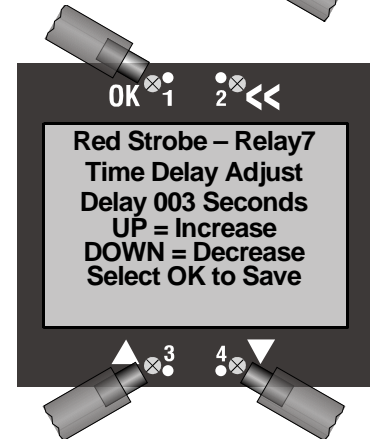
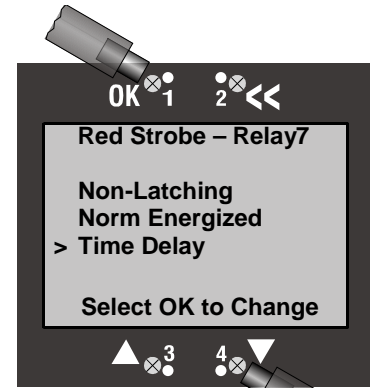

5 Menu Structure & Map

The setup and operation of the SensAlarm *Plus* is controlled by parameters and procedures that are accessed through the menu structure. The menu structure is entered from the Normal Operation Display by selecting OK. This brings up the Main Menu from which all other menus and menu items can be selected.

Basic Guide to Using the Menu System

Selecting OK from the Normal Operation Display enters the SensAlarm *Plus* menu system. Within the menu system OK is used in several ways: 1) to select an item from a list of menu items, 2) to confirm that an action has occurred (e.g. changing an alarm from “Non-Latching” to “Latching”), or 3) to save a new value that has been entered (e.g., a new alarm set point).

The << control returns to the previously displayed menu. If a change was in progress, the changes are discarded. It is similar in use to an ESC key on a computer keyboard.

The ▲ control arrow is used to move UP a list or back a page in menu items.

The ▼ control arrow is used to move DOWN a list or forward a page in menu items.

The ▲ and ▼ control arrows also are used to increase/decrease numeric values of certain menu items (e.g. alarm set point, cal gas concentration, etc.)

SENSALARM ^{PLUS} Menu Structure

5.1 Main Menu Screen

5.1.1. Calibration Mode

Last Cal @ ###PPM (%LEL, %VOL)

MM/DD/YY (YY/MM/DD) HH:MM:SS

5.1.1.1 Zero Transmitter

5.1.1.1.1 Apply ZERO gas Zeroing In Progress

5.1.1.1.2 Zero Complete” (either “Good” or “Fail”)

5.1.1.2 Calibrate

5.1.1.2.1 “Apply Gas Now”

5.1.1.2.2 “Cal In Progress” (stabilizing)

5.1.1.2.3 “Cal In Progress” (stable)

5.1.1.2.4 “Calibration Complete” (either “OK” or “FAIL”)

5.1.1.3 Set Cal Gas Conc

Use ▲ and ▼ to change value, and then select “OK” to save

5.1.2. Maintenance Mode

“Transmitter will be isolated for 10 minutes”

5.1.3. Data Review

5.1.3.1 Calibration Info

“Last Cal @ ## PPM(%VOL, %LEL)”
 DD/MM/YY (YY/MM/DD) HH:MM:SS
 PreCal Val ##PPM (%VOL, %LEL)

5.1.3.2 Sensor Status

Gas Name \$\$\$\$ ##
 TWA Conc ## PPM (%LEL) (%VOL)
 Sensor Life Remaining
 ### %

5.1.3.3 Sensor Data

Max Exposure ## PPM (%LEL) (%VOL)
 MM/DD/YY (YY/MM/DD) HH:MM:SS
 Sensor Temp C ##.#
 Max Temp C ##.#
 MM/DD/YY (YY/MM/DD) HH:MM:SS
 Min Temp C ##.#

5.1.3.4 Active Alarm/Faults

(only “Active” Alarms and Faults displayed)

5.1.3.5 Fault Currents

Head Fail ###
 Missing Sensor ###
 Sensor Fail ###
 Sensor E O L ###
 Out Curr Track ###
 Calibration Mode ###
 Maintenance Mode ###
 TOD Fail ###
 TOD End Of Life ###

5.1.3.6 Fault Current Delay

Sensor EOL ##
 Missing Sensor ##
 Sensor Fail ##
 Sensor E O L ##

5.1.3.7 Rly Alm Fault Config

5.1.3.7.1 Relay 1 – Fail

Latching (Non-Latching)
Norm Energized (Norm De-Energized)
Time Delay ### Sec.

5.1.3.7.2 Relay 2

Latching (Non-Latching)
Norm Energized (Norm De-Energized)
Time Delay ### Sec.

5.1.3.7.3 Relay 3

Latching (Non-Latching)
Norm Energized (Norm De-Energized)
Time Delay ### Sec.

5.1.3.7.4 Relay 4

Latching (Non-Latching)
Norm Energized (Norm De-Energized)
Time Delay ### Sec.

5.1.3.7.5 Warn (ing) Current Relay 5

Latching (Non-Latching)
Enabled (Disabled)
Low Curr(ent)Time (Delay) ### Sec.

5.1.3.7.6 Horn Relay 6

Latching (Non-Latching)
Timeout Enabled (Timeout Disabled)
Time Delay ### Sec
Timeout ### Seconds

5.1.3.7.7 Red Strobe – Relay 7

Latching (Non-Latching)
Norm Energized (Norm De-Energized)
Time Delay ### Sec

5.1.3.7.8 Amber Strobe - Relay 8

Latching (Non-Latching)
Norm Energized (Norm De-Energized)
Time Delay ### Sec

5.1.3.7.9 Alarm 1

Relays Assigned #####
Enabled (Disabled)
Ascending (Descending)
Set point ### PPM (%LEL) (%VOL)
Release Offs (Offset) ### PPM (%LEL) (%VOL)

5.1.3.7.10 Alarm 2

Relays Assigned #####
Enabled (Disabled)
Ascending (Descending)
Set point ### PPM (%LEL) (%VOL)
Release Offs (Offset)### PPM (%LEL) (%VOL)

5.1.3.7.11 Alarm 3

Relays Assigned #####
Enabled (Disabled)
Ascending (Descending)
Set point ### PPM (%LEL) (%VOL)
Release Offs (Offset) ### PPM (%LEL) (%VOL)

5.1.3.7.12 TWA (Time Weighted Average) Alarm

Relays Assigned #####
Enabled (Disabled)
Ascending (Descending)
Set point ### PPM (%LEL) (%VOL)
Average Time Adjust
Hours

5.1.3.7.13 TWA 2 (Time Weighted Average) Alarm

Relays Assigned #####
Enabled (Disabled)
Ascending (Descending)
Set point ### PPM (%LEL) (%VOL)
Average Time Adjust
Hours

5.1.3.7.14 Head Fail

Relays Assigned #####
Enabled (Disabled)
Fault Current #.##

5.1.3.7.15 Missing Sensor

Relays Assigned #####
Enabled (Disabled)
Fault Current #.##

5.1.3.7.16 Sensor Fail

Relays Assigned #####
Enabled (Disabled)
Fault Current #.##

5.1.3.7.17 Sensor EOL (End Of Life)

Relays Assigned #####
Enabled (Disabled)
Fault Current #.##
Current Delay ###

5.1.3.7.18 Out(put) Cur(rent) Track*Relays Assigned #####**Enabled (Disabled)**Fault Current #.##**Current Delay ###***5.1.3.7.19 Calibration Mode***Relays Assigned #####**Enabled (Disabled)**Fault Current #.##***5.1.3.7.20 Maintenance Mode***Relays Assigned #####**Enabled (Disabled)**Fault Current #.##***5.1.3.7.21 TOD (Test on Demand) Fail***Relays Assigned #####**Enabled (Disabled)**Fault Current #.##**Current Delay ###***5.1.3.7.22 TOD End Of Life***Relays Assigned #####**Enabled (Disabled)**Fault Current #.##**Current Delay ###***5.1.3.8 TOD Data Review***ToD Cell Present (Not Present)**Auto Mode Enabled (Disabled)**Last MM/DD/YY (YY/MM/DD) HH:MM**Last Test Passed (Failed)**Tests # Sec ##***5.1.3.9 Communication Reviews***4-20mA Communication**(None) SensAlert Sensor ID**No Comm Installed***5.1.3.9.1 HART Comm (if installed)***(No other settings)***5.1.3.9.2 Modbus Comm (if installed)***Add(ress) ### Baud (rate) #####**Parity Even (Odd) Stop 1 (2)***5.1.3.10 Firmware Review***Display Version ##.##**Head Version ##.##**Sensor Version ##.##*

Date Format **MM/DD/YY (YY/MM/DD)**

Comm Version (If installed) **##.##**

5.1.4. Test On Demand

5.1.4.1 4-20 mA Not Active

“In Progress” screen, then result

5.1.4.2 4-20 mA Active

“In Progress” screen, then result

5.1.5. System Configuration

5.1.5.1 Self Test

Turns on and off all pixels, lights all LEDs and activates all installed relays

5.1.5.2 Alarm Settings

Use Up Down For Next Selection Select “OK” to Access

5.1.5.2.1 Alarm Functions

Use Up Down For Next Selection Select “OK” to Access

5.1.5.2.1.1 Alarm 1

5.1.5.2.1.1.1 Add Relay

Use Up Down For Next Selection Select “OK” to Add

5.1.5.2.1.1.1.1 **Relay 1 – Fail**

5.1.5.2.1.1.1.2 **Relay 2**

5.1.5.2.1.1.1.3 **Relay 3**

5.1.5.2.1.1.1.4 **Relay 4**

5.1.5.2.1.1.1.5 **Warn Current-Relay 5**

5.1.5.2.1.1.1.6 **Horn -Relay 6**

5.1.5.2.1.1.1.7 **Red Strobe -Relay 7**

5.1.5.2.1.1.1.8 **Amber Strobe -Relay 8**

5.1.5.2.1.1.2 Delete Relay

Use Up Down For Next Selection Select “OK” to Add

5.1.5.2.1.1.2.1 **Relay 1 – Fail**

5.1.5.2.1.1.2.2 **Relay 2**

5.1.5.2.1.1.2.3 **Relay 3**

5.1.5.2.1.1.2.4 **Relay 4**

5.1.5.2.1.1.2.5 **Warn Current-Relay 5**

5.1.5.2.1.1.2.6 **Horn -Relay 6**

5.1.5.2.1.1.2.7 **Red Strobe -Relay 7**

5.1.5.2.1.1.2.8 **Amber Strobe -Relay 8**

5.1.5.2.1.1.3 Enabled ◀▶ Disabled

Select “OK” to change status

5.1.5.2.1.1.4 **Ascending ◀▶ Descending**

Select “OK” to change status

5.1.5.2.1.1.5 **Setpoint**

Use ▲ and ▼ to change value, then select “OK” to save

5.1.5.2.1.1.6 **Release Offset**

Select OK to Save,

UP= Increase

Down = Decrease

5.1.5.2.1.2 **Alarm 2**

Use Up Down For Next Selection Select “OK”

5.1.5.2.1.2.1 **Add Relay**

Use Up Down For Next Selection Select “OK” to Add

5.1.5.2.1.2.1.1 **Relay 1 – Fail**5.1.5.2.1.2.1.2 **Relay 2**5.1.5.2.1.2.1.3 **Relay 3**5.1.5.2.1.2.1.4 **Relay 4**5.1.5.2.1.2.1.5 **Warn Current-Relay 5**5.1.5.2.1.2.1.6 **Horn -Relay 6**5.1.5.2.1.2.1.7 **Red Strobe -Relay 7**5.1.5.2.1.2.1.8 **Amber Strobe -Relay 8**5.1.5.2.1.2.2 **Delete Relay**

Use Up Down For Next Selection Select “OK” to Add

5.1.5.2.1.2.2.1 **Relay 1 – Fail**5.1.5.2.1.2.2.2 **Relay 2**5.1.5.2.1.2.2.3 **Relay 3**5.1.5.2.1.2.2.4 **Relay 4**5.1.5.2.1.2.2.5 **Warn Current-Relay 5**5.1.5.2.1.2.2.6 **Horn -Relay 6**5.1.5.2.1.2.2.7 **Red Strobe -Relay 7**5.1.5.2.1.2.2.8 **Amber Strobe -Relay 8**5.1.5.2.1.2.3 **Enabled ◀▶ Disabled**

Select “OK” to change status

5.1.5.2.1.2.4 **Ascending ◀▶ Descending**

Select “OK” to change status

5.1.5.2.1.2.5 **Setpoint**

Select OK to Save,

UP= Increase

Down = Decrease

5.1.5.2.1.2.6 **Release Offset**

Select OK to Save,

UP= Increase

Down = Decrease

5.1.5.2.1.3 **Alarm 3**

Use Up Down For Next Selection Select "OK"

5.1.5.2.1.3.1 **Add Relay**

Use Up Down For Next Selection Select "OK" to Add

5.1.5.2.1.3.1.1 **Relay 1 – Fail**5.1.5.2.1.3.1.2 **Relay 2**5.1.5.2.1.3.1.3 **Relay 3**5.1.5.2.1.3.1.4 **Relay 4**5.1.5.2.1.3.1.5 **Warn Current-Relay 5**5.1.5.2.1.3.1.6 **Horn -Relay 6**5.1.5.2.1.3.1.7 **Red Strobe -Relay 7**5.1.5.2.1.3.1.8 **Amber Strobe -Relay 8**5.1.5.2.1.3.2 **Delete Relay**

Use Up Down For Next Selection Select "OK" to Add

5.1.5.2.1.3.2.1 **Relay 1 – Fail**5.1.5.2.1.3.2.2 **Relay 2**5.1.5.2.1.3.2.3 **Relay 3**5.1.5.2.1.3.2.4 **Relay 4**5.1.5.2.1.3.2.5 **Warn Current-Relay 5**5.1.5.2.1.3.2.6 **Horn -Relay 6**5.1.5.2.1.3.2.7 **Red Strobe -Relay 7**5.1.5.2.1.3.2.8 **Amber Strobe -Relay 8**5.1.5.2.1.3.3 **Enabled ◀▶ Disabled**

Select "OK" to change status

5.1.5.2.1.3.4 **Ascending ◀▶ Descending**

Select "OK" to change status

5.1.5.2.1.3.5 **Setpoint**

Select OK to Save,

UP= Increase

Down = Decrease

5.1.5.2.1.3.6 **Release Offset**

Select OK to Save,

UP= Increase

Down = Decrease

5.1.5.2.1.4 TWA Alarm

Use Up Down For Next Selection Select "OK"

5.1.5.2.1.4.1 Add Relay

Use Up Down For Next Selection Select "OK" to Add

- 5.1.5.2.1.4.1.1 **Relay 1 – Fail**
- 5.1.5.2.1.4.1.2 **Relay 2**
- 5.1.5.2.1.4.1.3 **Relay 3**
- 5.1.5.2.1.4.1.4 **Relay 4**
- 5.1.5.2.1.4.1.5 **Warn Current-Relay 5**
- 5.1.5.2.1.4.1.6 **Horn -Relay 6**
- 5.1.5.2.1.4.1.7 **Red Strobe -Relay 7**
- 5.1.5.2.1.4.1.8 **Amber Strobe -Relay 8**

5.1.5.2.1.4.2 Delete Relay

Use Up Down For Next Selection Select "OK" to Add

- 5.1.5.2.1.4.2.1 **Relay 1 – Fail**
- 5.1.5.2.1.4.2.2 **Relay 2**
- 5.1.5.2.1.4.2.3 **Relay 3**
- 5.1.5.2.1.4.2.4 **Relay 4**
- 5.1.5.2.1.4.2.5 **Warn Current-Relay 5**
- 5.1.5.2.1.4.2.6 **Horn -Relay 6**
- 5.1.5.2.1.4.2.7 **Red Strobe -Relay 7**
- 5.1.5.2.1.4.2.8 **Amber Strobe -Relay 8**

5.1.5.2.1.4.3 Enabled ◀▶ Disabled

Select "OK" to change status

5.1.5.2.1.4.4 Ascending ◀▶ Descending

Select "OK" to change status

5.1.5.2.1.4.5 Setpoint

Select OK to Save,

UP= Increase

Down = Decrease

5.1.5.2.1.4.6 Average Time Adjust

- 5.1.5.2.1.4.6.1 **15 Minutes**
- 5.1.5.2.1.4.6.2 **30 Minutes**
- 5.1.5.2.1.4.6.3 **60 Minutes**
- 5.1.5.2.1.4.6.4 **2 Hours**
- 5.1.5.2.1.4.6.5 **4 Hours**
- 5.1.5.2.1.4.6.6 **8 Hours**

5.1.5.2.1.5 TWA 2 Alarm

Use Up Down For Next Selection Select "OK"

5.1.5.2.1.5.1 Add Relay

Use Up Down For Next Selection Select "OK" to Add

- 5.1.5.2.1.5.1.1 **Relay 1 – Fail**
- 5.1.5.2.1.5.1.2 **Relay 2**
- 5.1.5.2.1.5.1.3 **Relay 3**
- 5.1.5.2.1.5.1.4 **Relay 4**
- 5.1.5.2.1.5.1.5 **Warn Current-Relay 5**
- 5.1.5.2.1.5.1.6 **Horn -Relay 6**
- 5.1.5.2.1.5.1.7 **Red Strobe -Relay 7**
- 5.1.5.2.1.5.1.8 **Amber Strobe -Relay 8**

5.1.5.2.1.5.2 Delete Relay

Use Up Down For Next Selection Select "OK" to Add

- 5.1.5.2.1.5.2.1 **Relay 1 – Fail**
- 5.1.5.2.1.5.2.2 **Relay 2**
- 5.1.5.2.1.5.2.3 **Relay 3**
- 5.1.5.2.1.5.2.4 **Relay 4**
- 5.1.5.2.1.5.2.5 **Warn Current-Relay 5**
- 5.1.5.2.1.5.2.6 **Horn -Relay 6**
- 5.1.5.2.1.5.2.7 **Red Strobe -Relay 7**
- 5.1.5.2.1.5.2.8 **Amber Strobe -Relay 8**

5.1.5.2.1.5.3 Enabled ◀▶ Disabled

Select "OK" to change status

5.1.5.2.1.5.4 Ascending ▶ Descending

Select "OK" to change status

5.1.5.2.1.5.5 Setpoint

Select OK to Save,

UP= Increase

Down = Decrease

5.1.5.2.1.5.6 Average Time Adjust

- 5.1.5.2.1.5.6.1 **0.5 Minutes**
- 5.1.5.2.1.5.6.2 **1 Minute**
- 5.1.5.2.1.5.6.3 **2 Minutes**
- 5.1.5.2.1.5.6.4 **5 Minutes**
- 5.1.5.2.1.5.6.5 **10 Minutes**
- 5.1.5.2.1.5.6.6 **20 Minutes**

5.1.5.2.2 Fault Functions

Use Up Down For Next Selection Select "OK" to Access

5.1.5.2.2.1 Head Fail

Use Up Down For Next Selection Select "OK"

5.1.5.2.2.1.1 Add Relay

Use Up Down For Next Selection Select "OK" to Add

5.1.5.2.2.1.1.1 **Relay 1 – Fail**

5.1.5.2.2.1.1.2 **Relay 2**

5.1.5.2.2.1.1.3 **Relay 3**

5.1.5.2.2.1.1.4 **Relay 4**

5.1.5.2.2.1.1.5 **Horn -Relay 6**

5.1.5.2.2.1.1.6 **Red Strobe -Relay 7**

5.1.5.2.2.1.1.7 **Amber Strobe -Relay 8**

5.1.5.2.2.1.2 Delete Relay

Use Up Down For Next Selection Select "OK" to Add

5.1.5.2.2.1.2.1 **Relay 1 – Fail**

5.1.5.2.2.1.2.2 **Relay 2**

5.1.5.2.2.1.2.3 **Relay 3**

5.1.5.2.2.1.2.4 **Relay 4**

5.1.5.2.2.1.2.5 **Horn -Relay 6**

5.1.5.2.2.1.2.6 **Red Strobe -Relay 7**

5.1.5.2.2.1.2.7 **Amber Strobe -Relay 8**

5.1.5.2.2.1.3 Enabled ◀▶ Disabled

Select "OK" to change status

5.1.5.2.2.1.4 Adj Fault Current

Select OK to Save,

UP= Increase

Down = Decrease

5.1.5.2.2.2 Missing Sensor

Use Up Down For Next Selection Select "OK"

5.1.5.2.2.2.1 Add Relay

Use Up Down For Next Selection Select "OK" to Add

5.1.5.2.2.2.1.1 **Relay 1 – Fail**

5.1.5.2.2.2.1.2 **Relay 2**

5.1.5.2.2.2.1.3 **Relay 3**

5.1.5.2.2.2.1.4 **Relay 4**

5.1.5.2.2.2.1.5 **Horn -Relay 6**

5.1.5.2.2.2.1.6 **Red Strobe -Relay 7**

5.1.5.2.2.2.1.7 **Amber Strobe -Relay 8**

5.1.5.2.2.2.2 Delete Relay

Use Up Down For Next Selection Select "OK" to Add

5.1.5.2.2.2.2.1 **Relay 1 – Fail**

5.1.5.2.2.2.2.2 **Relay 2**

5.1.5.2.2.2.2.3 **Relay 3**

5.1.5.2.2.2.2.4 **Relay 4**

5.1.5.2.2.2.2.5 **Horn -Relay 6**

5.1.5.2.2.2.2.6 **Red Strobe -Relay 7**

5.1.5.2.2.2.2.7 **Amber Strobe -Relay 8**

5.1.5.2.2.2.3 Enabled ◀▶ Disabled

Select "OK" to change status

5.1.5.2.2.2.4 Adj Fault Current

Select OK to Save,

UP= Increase

Down = Decrease

5.1.5.2.2.3 Sensor Fail

Use Up Down For Next Selection Select "OK"

5.1.5.2.2.3.1 Add Relay

Use Up Down For Next Selection Select "OK" to Add

5.1.5.2.2.3.1.1 **Relay 1 – Fail**

5.1.5.2.2.3.1.2 **Relay 2**

5.1.5.2.2.3.1.3 **Relay 3**

5.1.5.2.2.3.1.4 **Relay 4**

5.1.5.2.2.3.1.5 **Horn -Relay 6**

5.1.5.2.2.3.1.6 **Red Strobe -Relay 7**

5.1.5.2.2.3.1.7 **Amber Strobe -Relay 8**

5.1.5.2.2.3.2 Delete Relay

Use Up Down For Next Selection Select "OK" to Add

5.1.5.2.2.3.2.1 **Relay 1 – Fail**

5.1.5.2.2.3.2.2 **Relay 2**

5.1.5.2.2.3.2.3 **Relay 3**

5.1.5.2.2.3.2.4 **Relay 4**

5.1.5.2.2.3.2.5 **Horn -Relay 6**

5.1.5.2.2.3.2.6 **Red Strobe -Relay 7**

5.1.5.2.2.3.2.7 **Amber Strobe -Relay 8**

5.1.5.2.2.3.3 Enabled ◀▶ Disabled

Select "OK" to change status

5.1.5.2.2.3.4 Adj Fault Current

Select OK to Save,

UP= Increase

Down = Decrease

5.1.5.2.2.4 Sensor End Of Life

Use Up Down For Next Selection Select "OK"

5.1.5.2.2.4.1 Add Relay

Use Up Down For Next Selection Select "OK" to Add

5.1.5.2.2.4.1.1 **Relay 1 – Fail**

5.1.5.2.2.4.1.2 **Relay 2**

5.1.5.2.2.4.1.3 **Relay 3**

5.1.5.2.2.4.1.4 **Relay 4**

5.1.5.2.2.4.1.5 **Horn -Relay 6**

5.1.5.2.2.4.1.6 **Red Strobe -Relay 7**

5.1.5.2.2.4.1.7 **Amber Strobe -Relay 8**

5.1.5.2.2.4.2 Delete Relay

Use Up Down For Next Selection Select "OK" to Add

5.1.5.2.2.4.2.1 **Relay 1 – Fail**

5.1.5.2.2.4.2.2 **Relay 2**

5.1.5.2.2.4.2.3 **Relay 3**

5.1.5.2.2.4.2.4 **Relay 4**

5.1.5.2.2.4.2.5 **Horn -Relay 6**

5.1.5.2.2.4.2.6 **Red Strobe -Relay 7**

5.1.5.2.2.4.2.7 **Amber Strobe -Relay 8**

5.1.5.2.2.4.3 Enabled ◀▶ Disabled

Select "OK" to change status

5.1.5.2.2.4.4 **Adj Fault Current**

Select OK to Save,

UP= Increase

Down = Decrease

5.1.5.2.2.4.5 **Adj Current Delay**

Select OK to Save,

UP= Increase

Down = Decrease

5.1.5.2.2.5 **Output Current Track**

Use Up Down For Next Selection Select "OK"

5.1.5.2.2.5.1 **Add Relay**

Use Up Down For Next Selection Select "OK" to Add

5.1.5.2.2.5.1.1 **Relay 1 – Fail**5.1.5.2.2.5.1.2 **Relay 2**5.1.5.2.2.5.1.3 **Relay 3**5.1.5.2.2.5.1.4 **Relay 4**5.1.5.2.2.5.1.5 **Horn -Relay 6**5.1.5.2.2.5.1.6 **Red Strobe -Relay 7**5.1.5.2.2.5.1.7 **Amber Strobe -Relay 8**5.1.5.2.2.5.2 **Delete Relay**

Use Up Down For Next Selection Select "OK" to Add

5.1.5.2.2.5.2.1 **Relay 1 – Fail**5.1.5.2.2.5.2.2 **Relay 2**5.1.5.2.2.5.2.3 **Relay 3**5.1.5.2.2.5.2.4 **Relay 4**5.1.5.2.2.5.2.5 **Horn -Relay 6**5.1.5.2.2.5.2.6 **Red Strobe -Relay 7**5.1.5.2.2.5.2.7 **Amber Strobe -Relay 8**5.1.5.2.2.5.3 **Enabled ◀▶ Disabled**

Select "OK" to change status

5.1.5.2.2.5.4 **Adj Fault Current**

Select OK to Save,

UP= Increase

Down = Decrease

5.1.5.2.2.5.5 **Adj Current Delay**

Select OK to Save,

UP= Increase

Down = Decrease

5.1.5.2.2.6 Calibration Mode

Use Up Down For Next Selection Select "OK"

5.1.5.2.2.6.1 Add Relay

Use Up Down For Next Selection Select "OK" to Add

5.1.5.2.2.6.1.1 **Relay 1 – Fail**

5.1.5.2.2.6.1.2 **Relay 2**

5.1.5.2.2.6.1.3 **Relay 3**

5.1.5.2.2.6.1.4 **Relay 4**

5.1.5.2.2.6.1.5 **Horn -Relay 6**

5.1.5.2.2.6.1.6 **Red Strobe -Relay 7**

5.1.5.2.2.6.1.7 **Amber Strobe -Relay 8**

5.1.5.2.2.6.2 Delete Relay

Use Up Down For Next Selection Select "OK" to Add

5.1.5.2.2.6.2.1 **Relay 1 – Fail**

5.1.5.2.2.6.2.2 **Relay 2**

5.1.5.2.2.6.2.3 **Relay 3**

5.1.5.2.2.6.2.4 **Relay 4**

5.1.5.2.2.6.2.5 **Horn -Relay 6**

5.1.5.2.2.6.2.6 **Red Strobe -Relay 7**

5.1.5.2.2.6.2.7 **Amber Strobe -Relay 8**

5.1.5.2.2.6.3 Enabled ◀▶ Disabled

Select "OK" to change status

5.1.5.2.2.6.4 Adj Fault Current

Select OK to Save,

UP= Increase

Down = Decrease

5.1.5.2.2.7 Maintenance Mode

Use Up Down For Next Selection Select "OK"

5.1.5.2.2.7.1 Add Relay

Use Up Down For Next Selection Select "OK" to Add

5.1.5.2.2.7.1.1 **Relay 1 – Fail**

5.1.5.2.2.7.1.2 **Relay 2**

5.1.5.2.2.7.1.3 **Relay 3**

5.1.5.2.2.7.1.4 **Relay 4**

5.1.5.2.2.7.1.5 **Horn -Relay 6**

5.1.5.2.2.7.1.6 **Red Strobe -Relay 7**

5.1.5.2.2.7.1.7 **Amber Strobe -Relay 8**

5.1.5.2.2.7.2 **Delete Relay**

Use Up Down For Next Selection Select "OK" to Add

5.1.5.2.2.7.2.1 **Relay 1 – Fail**5.1.5.2.2.7.2.2 **Relay 2**5.1.5.2.2.7.2.3 **Relay 3**5.1.5.2.2.7.2.4 **Relay 4**5.1.5.2.2.7.2.5 **Horn -Relay 6**5.1.5.2.2.7.2.6 **Red Strobe -Relay 7**5.1.5.2.2.7.2.7 **Amber Strobe -Relay 8**5.1.5.2.2.7.3 **Enabled ◀▶ Disabled**

Select "OK" to change status

5.1.5.2.2.7.4 **Adj Fault Current**

Select OK to Save,

UP= Increase

Down = Decrease

5.1.5.2.2.8 **TOD Fail**

Use Up Down For Next Selection Select "OK"

5.1.5.2.2.8.1 **Add Relay**

Use Up Down For Next Selection Select "OK" to Add

5.1.5.2.2.8.1.1 **Relay 1 – Fail**5.1.5.2.2.8.1.2 **Relay 2**5.1.5.2.2.8.1.3 **Relay 3**5.1.5.2.2.8.1.4 **Relay 4**5.1.5.2.2.8.1.5 **Horn -Relay 6**5.1.5.2.2.8.1.6 **Red Strobe -Relay 7**5.1.5.2.2.8.1.7 **Amber Strobe -Relay 8**5.1.5.2.2.8.2 **Delete Relay**

Use Up Down For Next Selection Select "OK" to Add

5.1.5.2.2.8.2.1 **Relay 1 – Fail**5.1.5.2.2.8.2.2 **Relay 2**5.1.5.2.2.8.2.3 **Relay 3**5.1.5.2.2.8.2.4 **Relay 4**5.1.5.2.2.8.2.5 **Horn -Relay 6**5.1.5.2.2.8.2.6 **Red Strobe -Relay 7**5.1.5.2.2.8.2.7 **Amber Strobe -Relay 8**5.1.5.2.2.8.3 **Enabled ◀▶ Disabled**

Select "OK" to change status

5.1.5.2.2.8.4 **Adj Fault Current**

Select OK to Save,

UP= Increase

Down = Decrease

5.1.5.2.2.8.5 **Adj Current Delay**

Select OK to Save,

UP= Increase

Down = Decrease

5.1.5.2.2.9 **TOD End Of Life**

Use Up Down For Next Selection Select "OK"

5.1.5.2.2.9.1 **Add Relay**

Use Up Down For Next Selection Select "OK" to Add

5.1.5.2.2.9.1.1 **Relay 1 – Fail**5.1.5.2.2.9.1.2 **Relay 2**5.1.5.2.2.9.1.3 **Relay 3**5.1.5.2.2.9.1.4 **Relay 4**5.1.5.2.2.9.1.5 **Horn -Relay 6**5.1.5.2.2.9.1.6 **Red Strobe -Relay 7**5.1.5.2.2.9.1.7 **Amber Strobe -Relay 8**5.1.5.2.2.9.2 **Delete Relay**

Use Up Down For Next Selection Select "OK" to Add

5.1.5.2.2.9.2.1 **Relay 1 – Fail**5.1.5.2.2.9.2.2 **Relay 2**5.1.5.2.2.9.2.3 **Relay 3**5.1.5.2.2.9.2.4 **Relay 4**5.1.5.2.2.9.2.5 **Horn -Relay 6**5.1.5.2.2.9.2.6 **Red Strobe -Relay 7**5.1.5.2.2.9.2.7 **Amber Strobe -Relay 8**5.1.5.2.2.9.3 **Enabled ◀▶ Disabled**

Select "OK" to change status

5.1.5.2.2.9.4 **Adj Fault Current**

Select OK to Save,

UP= Increase

Down = Decrease

5.1.5.2.2.9.5 **Adj Current Delay**

Select OK to Save,

UP= Increase

Down = Decrease

5.1.5.2.3 Relay 1 – Fail

Use Up Down For Next Selection

5.1.5.2.3.1 Latching ◀▶ Non- Latching

Select “OK” to change status

5.1.5.2.3.2 Norm Energized ◀▶ Norm De-energized

Select “OK” to change status

5.1.5.2.3.3 Time Delay

UP= Increase

Down = Decrease

Select OK to Save,

5.1.5.2.4 Relay 2

Use Up Down For Next Selection

5.1.5.2.4.1 Latching ◀▶ Non- Latching

Select “OK” to change status

5.1.5.2.4.2 Norm Energized ◀▶ Norm De-energized

Select “OK” to change status

5.1.5.2.4.3 Time Delay

UP= Increase

Down = Decrease

Select OK to Save,

5.1.5.2.5 Relay 3

Use Up Down For Next Selection

5.1.5.2.5.1 Latching ◀▶ Non- Latching

Select “OK” to change status

5.1.5.2.5.2 Norm Energized ◀▶ Norm De-energized

Select “OK” to change status

5.1.5.2.5.3 Time Delay

UP= Increase

Down = Decrease

Select OK to Save,

5.1.5.2.6 Relay 4

Use Up Down For Next Selection

5.1.5.2.6.1 Latching ◀▶ Non- Latching

Select “OK” to change status

5.1.5.2.6.2 Norm Energized ◀▶ Norm De-energized

Select “OK” to change status

5.1.5.2.6.3 Time Delay

UP= Increase

Down = Decrease

Select OK to Save,

5.1.5.2.7 Warn Current – Relay 5

Use Up Down For Next Selection

5.1.5.2.7.1 Latching ◀▶ Non- Latching

Select "OK" to change status

5.1.5.2.7.2 Enabled ◀▶ Disabled

Select "OK" to change status

5.1.5.2.7.3 Low Current Time Adj

UP= Increase

Down = Decrease

Select OK to Save,

5.1.5.2.8 Horn - Relay 6

Use Up Down For Next Selection

5.1.5.2.8.1 Latching ◀▶ Non- Latching

Select "OK" to change status

5.1.5.2.8.2 Timeout Disabled ◀▶ Timeout Enabled

Select "OK" to change status

5.1.5.2.8.3 Time Delay

UP= Increase

Down = Decrease

Select OK to Save,

5.1.5.2.8.4 Timeout Delay

UP= Increase

Down = Decrease

Select OK to Save,

5.1.5.2.9 Red Strobe - Relay 7

Use Up Down For Next Selection

5.1.5.2.9.1 Latching ◀▶ Non- Latching

Select "OK" to change status

5.1.5.2.9.2 Norm Energized ◀▶ Norm De-energized

Select "OK" to change status

5.1.5.2.9.3 Time Delay

UP= Increase

Down = Decrease

Select OK to Save,

5.1.5.2.10 Amber Strobe - Relay 8

Use Up Down For Next Selection

5.1.5.2.10.1 Latching ◀▶ Non- Latching

Select "OK" to change status

5.1.5.2.10.2 Norm Energized ◀▶ Norm De-energized

Select "OK" to change status

5.1.5.2.10.3 Time Delay

UP= Increase

Down = Decrease

Select OK to Save,

5.1.5.3 4/20ma Adjustment

Use ▲ and ▼ to change selection

5.1.5.3.1 4 mA

Up = Increase

Down Decrease

Select OK to Complete

Select << To Cancel

5.1.5.3.2 20 mA

Up = Increase

Down Decrease

Select OK to Complete

Select << To Cancel

5.1.5.3.3 1 mA

Up = Increase

Down Decrease

Select OK to Complete

Select << To Cancel

5.1.5.4 Adjust Date/Time

Use ▲ and ▼ to change value

5.1.5.4.1 If MM/DD/YY

5.1.5.4.1.1 Month

Use ▲ and ▼ to change value, then OK

5.1.5.4.1.2 Date

Use ▲ and ▼ to change value, then OK

5.1.5.4.1.3 Year

Use ▲ and ▼ to change value, then OK

5.1.5.4.1.4 Hour

Use ▲ and ▼ to change value, then OK

5.1.5.4.1.5 Minute

Use ▲ and ▼ to change value, then OK

5.1.5.4.2 If DD/MM/YY

5.1.5.4.2.1 Date

Use ▲ and ▼ to change value, then OK

5.1.5.4.2.2 Month

Use ▲ and ▼ to change value, then OK

5.1.5.4.2.3 **Year**

Use ▲ and ▼ to change value, then OK

5.1.5.4.2.4 **Hour**

Use ▲ and ▼ to change value, then OK

5.1.5.4.2.5 **Minute**

Use ▲ and ▼ to change value, then OK

5.1.5.5 Communications Setup

Use ▲ and ▼ to change value

5.1.5.5.1 **4-20 mA communication**5.1.5.5.1.1 **None**

Select OK To Save

5.1.5.5.1.2 **SensAlert Sensor ID**

Select OK To Save

5.1.5.5.2 **No Comm Installed**5.1.5.5.3 **ModBus Comm (if Installed)**5.1.5.5.3.1 **Modbus Address**

Modbus Address ###

Use ▲ and ▼ to change value, then OK

5.1.5.5.3.2 **Baud Rate**

Use ▲ and ▼ to change value

5.1.5.5.3.2.1 **9600**

Select OK To Save

5.1.5.5.3.2.2 **19200**

Select OK To Save

5.1.5.5.3.2.3 **38400**

Select OK To Save

5.1.5.5.3.3 **Parity**

Use ▲ and ▼ to change value

5.1.5.5.3.3.1 **None**

Select OK To Save

5.1.5.5.3.3.2 **Odd**

Select OK To Save

5.1.5.5.3.3.3 **Even**

Select OK To Save

5.1.5.5.3.4 **Stop Bits**

Use ▲ and ▼ to change value

5.1.5.5.3.4.1 **1**

Select OK To Save

5.1.5.5.3.4.2 **2**

Select OK To Save

5.1.5.5.4 **Hart Comm (if Installed)**

No user adjustments

5.1.5.6 **TOD Mode Adjustment**

5.1.5.6.1 **Auto Mode Enable**

Use ▲ and ▼ to change selection

5.1.5.6.1.1 **Disable Automatic**

Select OK To Save

5.1.5.6.1.2 **Enable Automatic**

Select OK To Save

5.1.5.6.2 **Test Date/Time**

5.1.5.6.2.1 *If Date Format is DD/MM/YY*

5.1.5.6.2.1.1 **Date**

Use ▲ and ▼ to change value, then OK

5.1.5.6.2.1.2 **Month**

Use ▲ and ▼ to change value, then OK

5.1.5.6.2.1.3 **Year**

Use ▲ and ▼ to change value, then OK

5.1.5.6.2.1.4 **Hour**

Use ▲ and ▼ to change value, then OK

5.1.5.6.2.1.5 **Minute**

Use ▲ and ▼ to change value, then OK

5.1.5.6.2.2 *If Date Format is MM/DD/YY*

5.1.5.6.2.2.1 **Month**

Use ▲ and ▼ to change value, then OK

5.1.5.6.2.2.2 **Date**

Use ▲ and ▼ to change value, then OK

5.1.5.6.2.2.3 **Year**

Use ▲ and ▼ to change value, then OK

5.1.5.6.2.2.4 **Hour**

Use ▲ and ▼ to change value, then OK

5.1.5.6.2.2.5 **Minute**

Use ▲ and ▼ to change value, then OK

5.1.5.6.3 Days Between Tests

"Adj Num Of Days"

##

Use ▲ and ▼ to change value, then OK

5.1.5.6.4 Cell Intensity

"50% Is Nominal"

"Cell Intensity" ###%

Up = Increase

Down Decrease

Use ▲ and ▼ to change value, then OK

5.1.5.6.5 Output Indicators**5.1.5.6.5.1 None**

Select OK To Save

5.1.5.6.5.2 4-20 Current Loop

Select OK To Save

5.1.5.7 Sensor Adjustment

If Toxic or Oxygen sensor installed

No Adjustments Are Possible

Use ▲ and ▼ to change selection

5.1.5.7.1 Select Cal Gas

(CB or IR CMB Sensor installed)

Use ▲ and ▼ to change selection

5.1.5.7.1.1 Methane

"Methane

Has Been Selected"

Select OK To Save

(If IR CMB Sensor installed, and Cal Gas was Propane, Monitor will restart)

Select << to Cancel

5.1.5.7.1.2 Propane

"Propane

Has Been Selected"

Select OK To Save

(If IR CMB Sensor installed, and Cal Gas was Methane, Monitor will restart)

Select << to Cancel

5.1.5.7.1.3 Other

"Other

Has Been Selected"

Select OK To Save

(If IR CMB Sensor installed, and Cal Gas was not Other, Monitor will restart)

Select << to Cancel

5.1.5.7.2 **Select K Factor**

***If CB CMB Sensor is installed
And Cal Gas Is Methane”***

Use ▲ and ▼ to change selection

5.1.5.7.2.1 **None**

None

K Factor is: 1.00”

Select OK To Save

Select << to Cancel

5.1.5.7.2.2 **Hydrogen**

Hydrogen

K Factor is: 1.23”

Select OK To Save

Select << to Cancel

5.1.5.7.2.3 **Propane**

Propane

K Factor is: 1.90”

Select OK To Save

Select << to Cancel

5.1.5.7.2.4 **Hexane**

Hexane

K Factor is: 2.33”

Select OK To Save

Select << to Cancel

5.1.5.7.2.5 **Butane**

Butane

K Factor is: 2.03”

Select OK To Save

Select << to Cancel

5.1.5.7.2.6 **Custom K Factor**

Custom K Factor

K Factor is: 2.03”

Use ▲ and ▼ to change value, then OK

Select OK To Save

Select << to Cancel

5.1.5.7.3 **Select K Factor**

***If CB CMB Sensor is installed
And Cal Gas Is Propane”***

Use ▲ and ▼ to change selection

5.1.5.7.3.1 **None**

None

K Factor is: 1.00"

Select OK To Save

Select << to Cancel

5.1.5.7.3.2 **Hydrogen**

Hydrogen

K Factor is: .65"

Select OK To Save

Select << to Cancel

5.1.5.7.3.3 **Methane**

Methane

K Factor is: .53"

Select OK To Save

Select << to Cancel

5.1.5.7.3.4 **Hexane**

Hexane

K Factor is: 1.23"

Select OK To Save

Select << to Cancel

5.1.5.7.3.5 **Butane**

Butane

K Factor is: 1.07"

Select OK To Save

Select << to Cancel

5.1.5.7.3.6 **Custom K Factor**

Custom K Factor

K Factor is: 1.07"

Use ▲ and ▼ to change value

Select OK To Save

Select << to Cancel

5.1.5.7.4 **Select K Factor**

***If CB CMB Sensor is installed
And Cal Gas Is Other"***

Use ▲ and ▼ to change selection

5.1.5.7.4.1 **None**

"None

K Factor is: 1.00"

Select OK To Save

Select << to Cancel

5.1.5.7.4.2 **Custom K Factor**

“Custom K Factor

K Factor is: 1.00”

Select OK To Save

Select << to Cancel

5.1.5.7.5 **Select K Factor**

***If IR CMB Sensor is installed
And Cal Gas Is Methane”***

Use ▲ and ▼ to change selection

5.1.5.7.5.1 **None**

None

K Factor is: 1.00”

Select OK To Save

Select << to Cancel

5.1.5.7.6 **Select K Factor**

***If IR CMB Sensor is installed
And Cal Gas Is Propane”***

Use ▲ and ▼ to change selection

5.1.5.7.6.1 **None**

None

K Factor is: 1.00”

Select OK To Save

Select << to Cancel

5.1.5.7.6.2 **Methanol**

Methanol

K Factor is: .57”

Select OK To Save

Select << to Cancel

5.1.5.7.6.3 **Butadiene**

Butadiene

K Factor is: 2.54”

Select OK To Save

Select << to Cancel

5.1.5.7.6.4 **Butane**

Butane

K Factor is: 1.19”

Select OK To Save

Select << to Cancel

5.1.5.7.6.5 Hexane*Hexane**K Factor is: 1.61”**Select OK To Save**Select << to Cancel***5.1.5.7.6.6 Custom K Factor***Custom K Factor**K Factor is: 1.07”**Use ▲ and ▼ to change value**Select OK To Save**Select << to Cancel***5.1.5.7.7 Select K Factor*****If IR CMB Sensor is installed
And Cal Gas Is Other”****Use ▲ and ▼ to change selection***5.1.5.7.7.1 None***”None**K Factor is: 1.00”**Select OK To Save**Select << to Cancel***5.1.5.7.7.2 Custom K Factor***”Custom K Factor**K Factor is: 1.00”**Use ▲ and ▼ to change value**Select OK To Save**Select << to Cancel***5.1.5.8 Set Password****5.1.5.8.1 0XXXXX****”6 Digits 0-9***Use ▲ and ▼ to change value each digit**Select OK To Save***Select << To Exit”****5.1.5.8.2 New Password Entered***Select OK To Save**Select << to Cancel*

5.1.5.9 Reset Defaults

*“This will reset all
Relays, Alarms, and
Faults to Factory
Default Values”*

*Select OK To Continue
(Selecting OK will restart the Monitor)
Select << to Cancel*

5.1.5.10 Set Transmitter Tag

5.1.5.10.1 \$

”_____SENSALERT_PLUS_____” is default

Use ▲ and ▼ to change each of 21 Characters

Select OK To Continue

Select OK after the last character to save

5.1.6. Lost Password

5.1.6.1 If no password installed

”No Password Installed”

5.1.6.2 If password installed

”Please Call Sensidyne

At 727-530-3602

Please Provide

This Code

#####”

5.2 Main Menu (screens)

As shown on the example display to the right, the top level (main) menu allows the selection of several submenus, documented below. Selecting **OK** brings up the submenus.

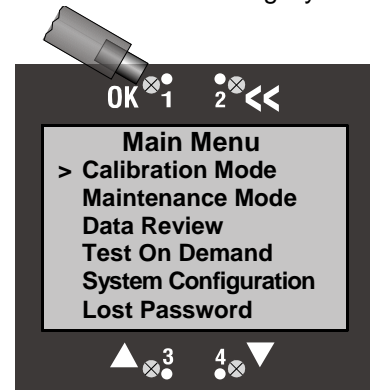

5.2.1 Calibration Mode

The Calibration mode menu shows information about the last calibration, including the concentration of gas used and the date and time of the last successful calibration. Refer to Section 3.1

Unless reset, the displayed gas concentration is assumed for the current calibration.

A complete calibration is done by zeroing the Monitor to establish the sensor response without any gas present, and the calibrate step which adjusts the response of the unit to a known concentration of gas. The combination of zero and calibrate steps adjusts the unit to display accurate measurements across the entire range of the sensor. The sensor contains an internally stored gas response curve that compensates variations caused by temperature excursions.

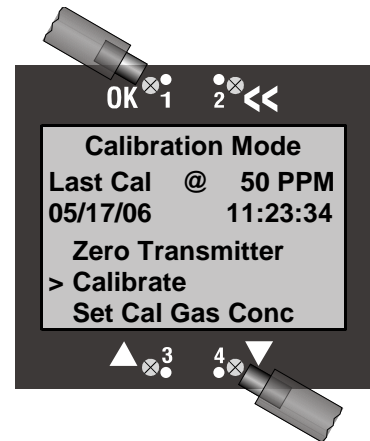

5.2.2 Zero Monitor

Refer to Section 3.1.1

When this menu item is selected, the unit displays a screen requesting the application of zero gas. It is important to use pure zero gas and not assume that the ambient is gas interferent free. When OK is selected, the zeroing in progress screen appears. After the zero gas reading stabilizes, the display will show “Zero Complete” and “Good” and the unit stores the zero gas value for subsequent use. If the gas reading does not stabilize, or the sensor output is not within acceptable limits the display will show “Zero Complete” and “Fail” and the previously stored zero reading will not be altered.

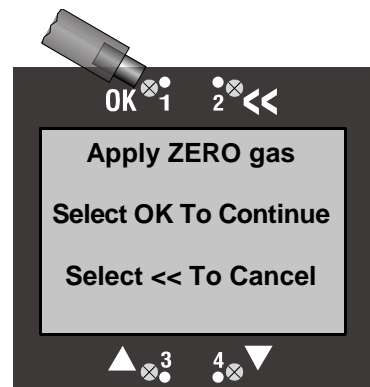

5.2.3 Calibrate

Refer to Section 3.1.2

When this menu item is selected, the unit suppresses the 4 – 20 mA output, displays “Apply Gas Now” and waits for calibration gas to be applied. The calibration plug should be used with a flow rate of 0.5 to 1.5 LPM. The concentration of gas used should match the value displayed on the screen. If you are using a different concentration, alter the setting using the “Set Cal Gas Concentration” menu item before entering Calibrate. After the gas reading stabilizes, the unit calculates a span calibration factor and stores it for subsequent use. If the gas reading does not stabilize, or the sensor output is not within acceptable limits the display will show “Fail” and the previously stored span value will not be altered.

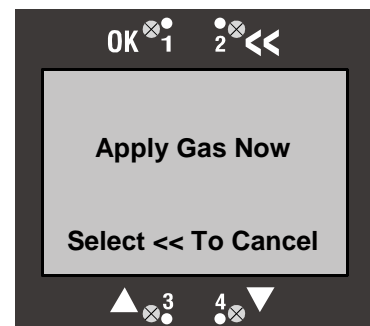

5.2.4 Set Cal Gas Concentration

Refer to Section 3.1.2

This menu item allows selecting the calibration gas concentration. The ▲ and ▼ keys can be used to adjust the concentration. The value will be stored when OK is selected and presented as the default value in subsequent span calibrations.

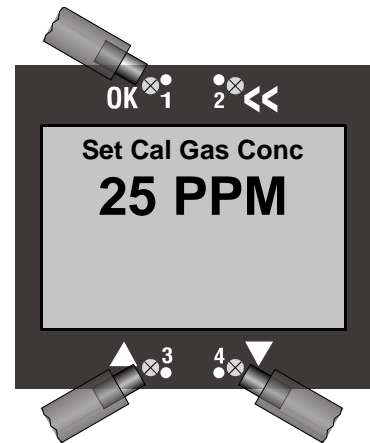

5.2.5 Maintenance Mode

Maintenance mode allows the output indication of the unit to be disabled for ten minutes. The outputs, both 4-20 ma and data communication, will not respond to gas during the maintenance mode time. On units equipped with Relays, the relays will not change state while in Maintenance Mode. This is to allow for periodic maintenance on the unit without setting off alarms.

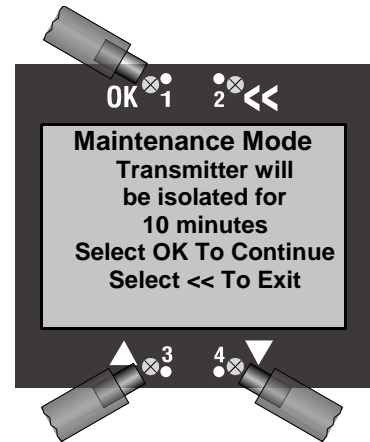

5.2.6 Data Review

Data review allows the examination of data stored by the unit. Data reviews are available for the Test-On-Demand gas generating cell, the installed sensor, Fault Currents, Active Alarms/Faults, Rly Alm Fault Config., Calibration Info, Communication Review, and Firmware Review.

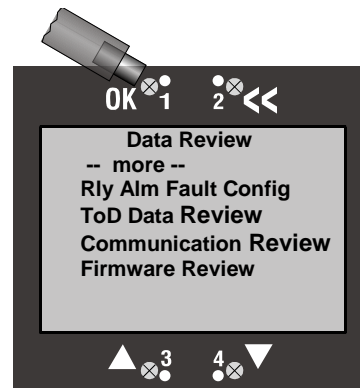
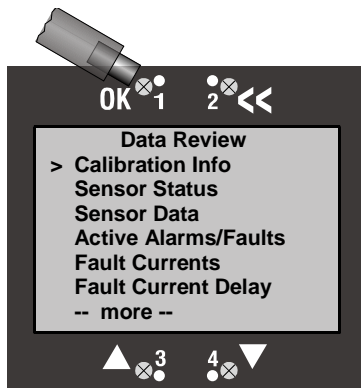

5.2.6.1 Calibration Info

The Calibration Info review screen displays the last Calibration gas concentration, the Date of last successful calibration, and Pre Calibration gas concentration (as found condition).

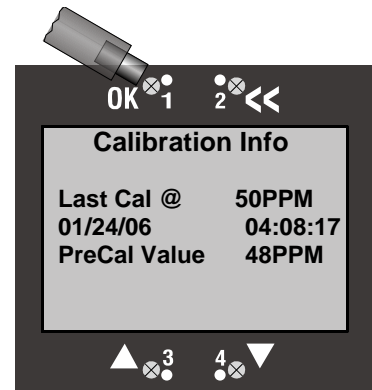

5.2.6.2 Sensor Status

The Sensor Status review screen displays the abbreviated gas name, upper range of the sensor, and Time Weighted Average Gas Concentration. It also displays the percentage of sensor life remaining. Sensors start at 100% and decline as they age. The Sensor End Of Life warning occurs at 10% Sensor Life Remaining.

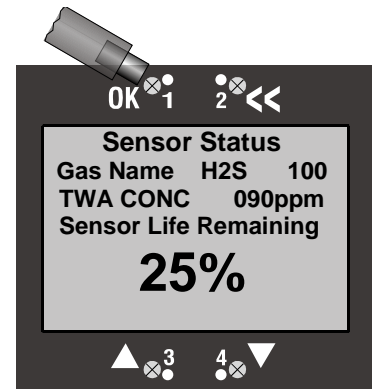

5.2.6.3 Sensor Data

The Sensor Data review screen displays maximum gas concentration with time stamp, present sensor temperature in degrees C, maximum sensor temperature with time stamp, and minimum sensor temperature with time stamp. All Sensor Data values are reset with a successful sensor calibration.

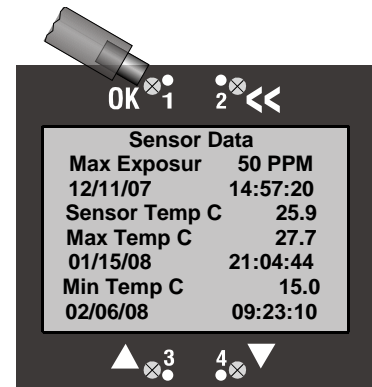

5.2.6.4 Active Alarms/Faults

The Active Alarms/Faults review screen displays the Active Alarms and Faults.

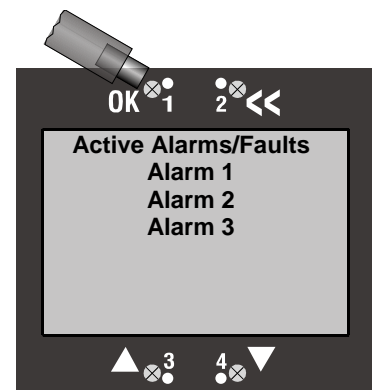

5.2.6.5 Fault Currents

The Fault Currents review screen displays the fault currents in mA for each of the nine Fault Functions.

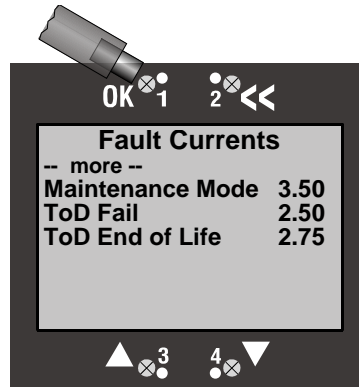
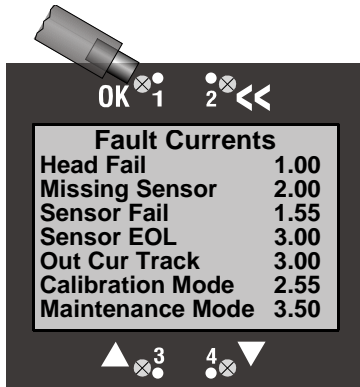

5.2.6.6 Fault Current Delay

The Fault Current Delay review screen displays the number of seconds of each hour that the Fault Current will be active for an active fault.

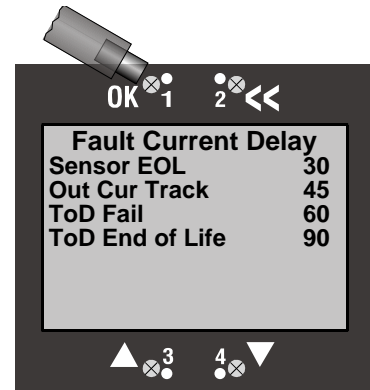

5.2.6.7 Rly Alm Fault Config

The Rly Alm Fault Config review screen displays the Relays, Alarms, and Fault settings.

- 5.2.6.7.1 Relay 1 – Fail
- 5.2.6.7.2 Relay 2
- 5.2.6.7.3 Relay 3
- 5.2.6.7.4 Relay 4
- 5.2.6.7.5 Warn Current – Relay 5
- 5.2.6.7.6 Horn – Relay 6
- 5.2.6.7.7 Red Strobe – Relay 7
- 5.2.6.7.8 Amber Strobe – Relay 8
- 5.2.6.7.9 Alarm 1
- 5.2.6.7.10 Alarm 2
- 5.2.6.7.11 Alarm 3
- 5.2.6.7.12 TWA Alarm
- 5.2.6.7.13 Head fail
- 5.2.6.7.14 Missing Sensor

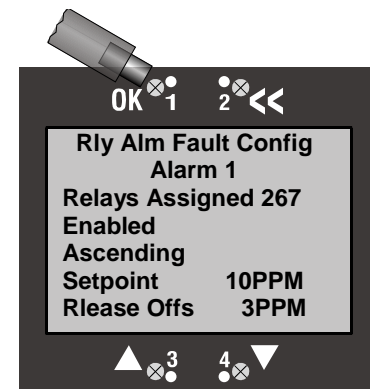
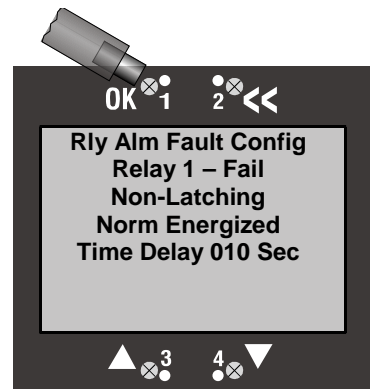

- 5.2.6.7.15 Sensor Fail
- 5.2.6.7.16 Sensor EOL
- 5.2.6.7.17 Out Cur Track
- 5.2.6.7.18 Calibration Mode
- 5.2.6.7.19 Maintenance Mode
- 5.2.6.7.20 ToD Fail
- 5.2.6.7.21 ToD End of Life

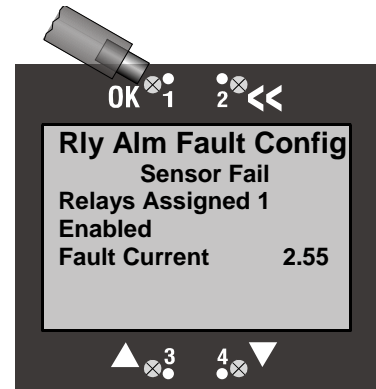

5.2.6.8 ToD Review

The ToD Review screen displays the data stored on the ToD cell. If a ToD cell is not installed “ToD Cell Not Present” will be displayed. The data displayed include the status of Auto Mode (Enabled/Disabled), the date and time of the next automatic ToD test (if Auto Mode Enabled), the date and time of the last ToD test, the results of the test (Pass/Fail), the number of tests that have been performed by the cell, and the total amount of testing time (in seconds).

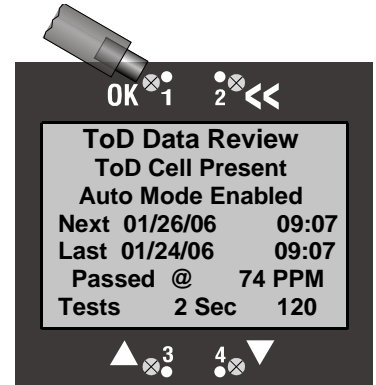

5.2.6.9 Communication Review

The Communication Review screen displays the present setting of the 4/20mA Current Loop (SensAlert sensor ID or None). Depending on which Communications Option is installed (None, HART, or Modbus) the display will vary.

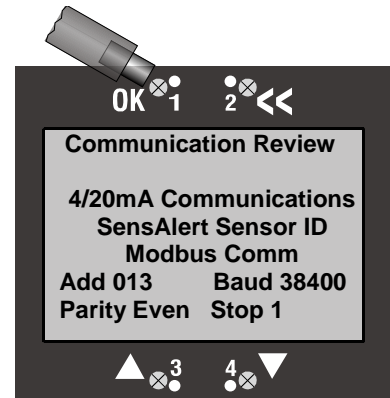

5.2.6.10 Firmware Review

The Firmware Review screen displays the firmware version of the display board, Sensor interface, sensor, and communications board if installed. Also the present Date Format the Display is using.

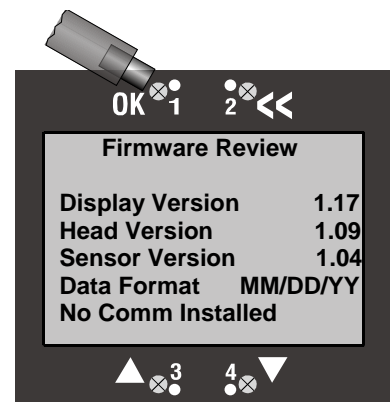

5.2.7 Test-On-Demand (Main Menu)

The Test-On-Demand™ menu item allows the unit to manually activate the gas generating cell to present gas to the sensor to qualitatively check the operation of the unit from sensor to analog and digital outputs. The outputs may be disabled to remain at nominal levels, or remain active so that the output connections can be tested. If the outputs are active, system gas alarms may be set off. The Test-On-Demand returns either a “ToD PASS” or “ToD FAIL” result. The Test-On-Demand can fail if a ToD cell is not present, there is gas present, or if a sensor that is incompatible with the ToD cell is installed. The Test-On-Demand feature can also be set to automatically perform these tests on a periodic basis (see Section 3.3).

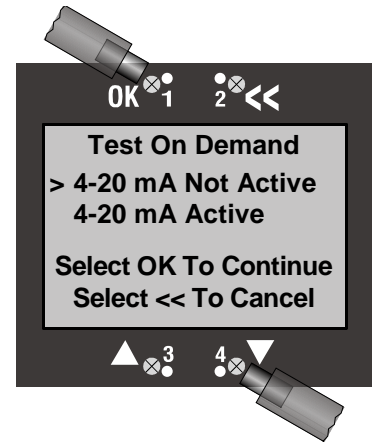

5.2.8 System Configuration

The System Configuration menu provides a large number of functions for configuring the operation of the unit. These include conducting a self test, alarm and relay setup, adjusting the 4 mA & 20 mA outputs, setting the date and time, communications setup, adjusting ToD cell functions, setting Combustible sensor parameters, and setting a password.

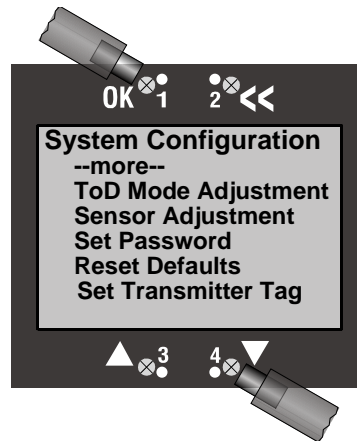
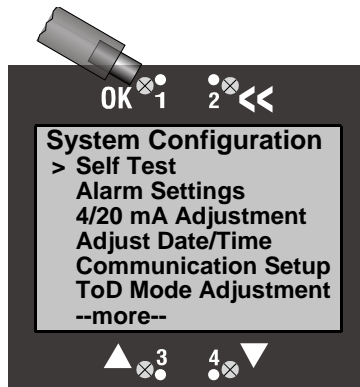

5.2.8.1 Self Test

The self test checks LED operation and activates all of the screen pixels for a visual inspection. In addition, all relays, horn, and strobes are tested.

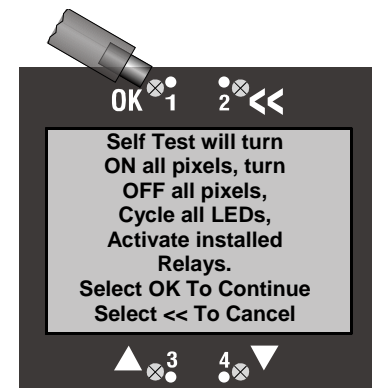

5.2.8.2 Alarm Settings

The Alarm Settings menu contains the following items: Alarm Functions, Fault Functions, Relay 1 – Fail, Relay 2, Relay 3, Relay 4, Warn Current -Relay 5, Horn - Relay 6, Red Strobe – Relay 7, and Amber Strobe – Relay 8. Each item is discussed below. See Section 4.1 for instructions on using the functions in the Alarm Settings menu.

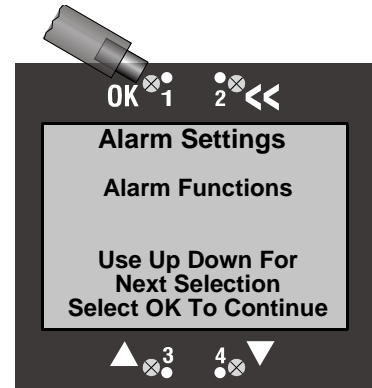

5.2.8.2.1 Alarm (or Fault) Functions

The Alarm Functions menu is used for setting and adjusting the three primary gas alarms (Alarm 1, Alarm 2, Alarm 3), as well as the TWA Alarm. Instructions for using this menu are found in Section 4.1

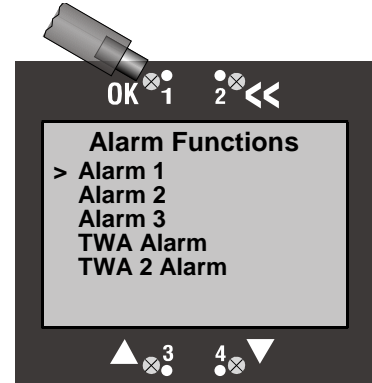

5.2.8.2.1.1 Alarm 1

Alarm 1 is usually associated with the lowest level alarm setpoint. Also known as the “LO” Alarm. The Alarm 1 screen is shown at the right. The descriptions of the functions for Alarm 1 are also applicable to Alarm 2, Alarm 3, and the TWA Alarm. The TWA Alarm, however, uses Average Time Adjust instead of Release Offset.

In this menu you can add or delete relays for Alarm 1, enable or disable the alarm, make the alarm ascending or descending, adjust the alarm setpoint, and change the release offset. These functions are discussed in greater detail in Section 4.1.

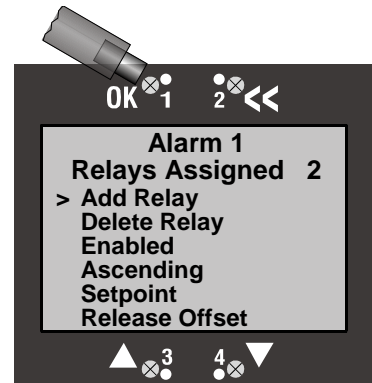

5.2.8.2.1.2 Alarm 2

Alarm 2 is usually associated with the next highest alarm setpoint. Also known as the “Hi” Alarm

5.2.8.2.1.3 Alarm 3

Alarm 3 is usually associated with the highest alarm setpoint. Also known as the “HiHi” Alarm.

5.2.8.2.1.4 TWA Alarm and TWA 2 Alarm

The TWA (Time Weighted Average) Alarm is a calculated alarm associated with gas exposure averaged over a fixed time period. The TWA time period can range from 15 minutes to 8 hours, and TWA 2 from 0.5 minutes to 20 minutes. Eight hours is considered the typical calculated time period.

The only function that differs from Alarm 1 – 3 is Average Time Adjust. This is the time period over which the TWA Alarm calculates its weighted average. The time period can range from 15 minutes to 8 hours. Whereas TWA 2 averaging range is from 0.5 minutes to 20 minutes.

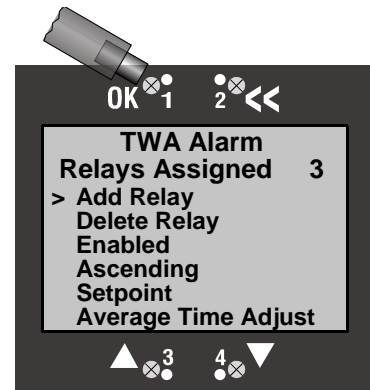

5.2.8.2.2 Fault Functions

The Fault Functions menu contains the following items:

- Head Fail
- Missing Sensor
- Sensor Fail
- Sensor End Of Life
- Output Current Track
- Calibration Mode
- Maintenance Mode
- TOD Fail
- TOD End Of Life

For detailed instructions covering these faults, see Section 4.2

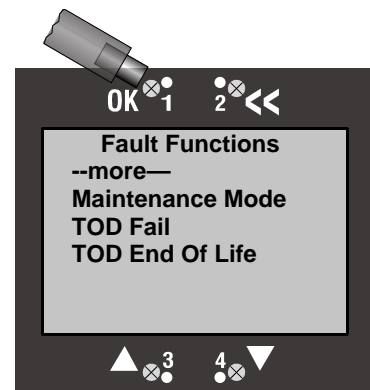
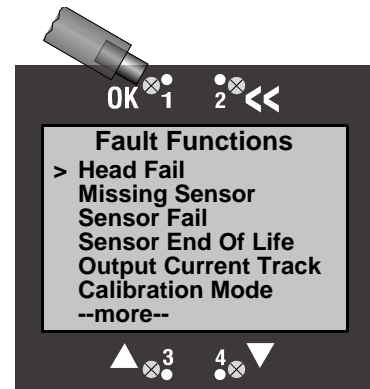

5.2.8.2.2.1 Head Fail

Head Fail is activated when communication from the display unit to the sensor interface has been disrupted. This can be caused by a failure of the head processor or interruption of the communication path.

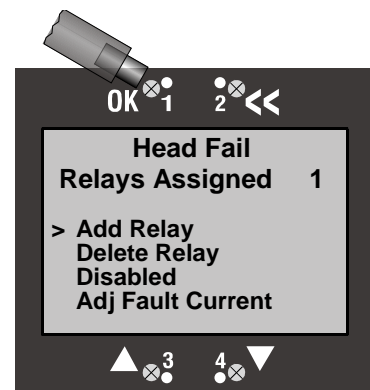

5.2.8.2.2.2 Missing Sensor

The Missing sensor fault is activated when communication between the Monitor and the sensor has been disrupted or the sensor has been removed.

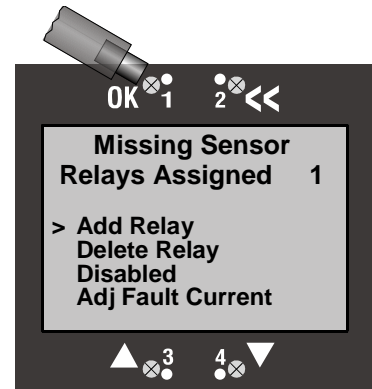

5.2.8.2.2.3 Sensor Fail

The Sensor Fail fault is activated when the output of the sensor shows that it is not operating properly.

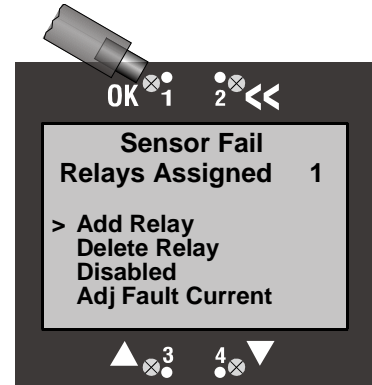

5.2.8.2.2.4 Sensor End of Life

The Sensor End Of Life fault is activated when the predicted life of the sensor falls below 10% of its initial lifetime expectation. The sensor lifetime expectation varies from gas type to gas type. It is based on the calculated predictive failure measurement, and a set of expected end-of-life conditions.

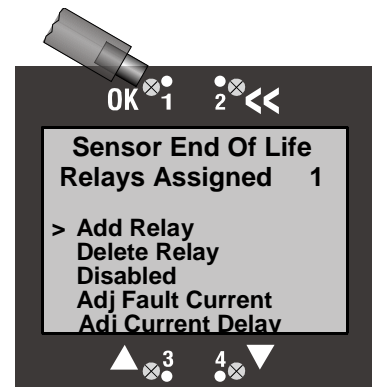

5.2.8.2.2.5 Output Current Track

The Output Current Track is activated when the actual output of the Monitor differs from the expected output of the system. This ensures that the 4-20 mA output agrees with the reading on the Monitor display. This warning function should be disabled when the 4-20 mA output loop is not used.

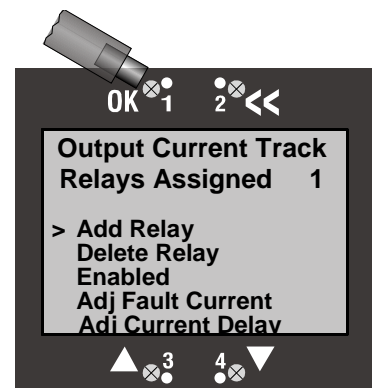

5.2.8.2.2.6 Calibration Mode

The Calibration Mode fault is activated when the Monitor is put into the Calibration Mode.

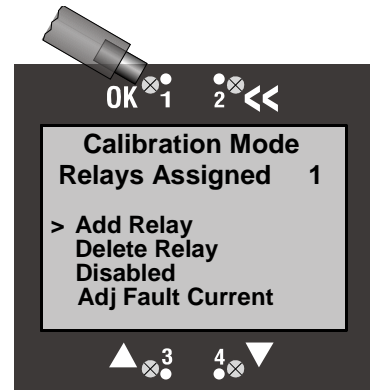

5.2.8.2.2.7 Maintenance Mode

The Calibration Mode fault is activated when the Monitor is put into the Maintenance Mode.

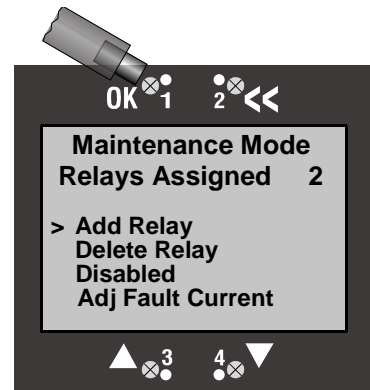

5.2.8.2.2.8 ToD Fail

The ToD Fail fault is activated when the Monitor fails a manual or automatic ToD test. The fault can be cleared by a successful ToD test or Disabling the fault function.

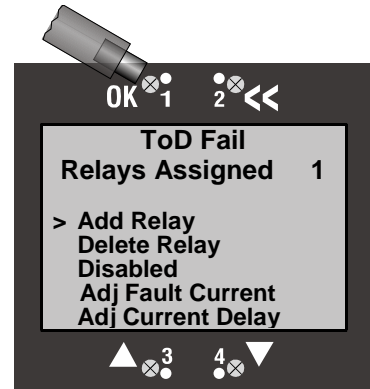

5.2.8.2.2.9 ToD End of Life

Tod end of life fault is activated when the predicted end of life of the ToD cell is reached. It is based on a set of expected end of life conditions

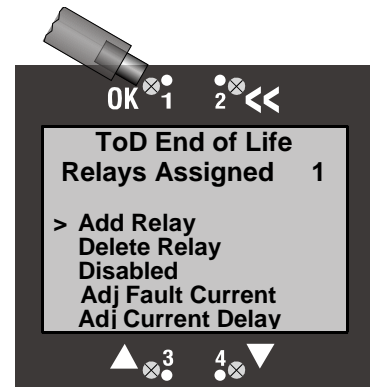

5.2.8.2.3 Relay 1 – Fail

This is the factory default relay for all warnings. Relay 1 can be set as latching or non-latching and normally energized or normally de-energized. The relay is shipped from the factory as “Non-Latching, Normally Energized, Time Delay – 10 Seconds.” The activation time delay for the relay is user adjustable. See Section 4.4

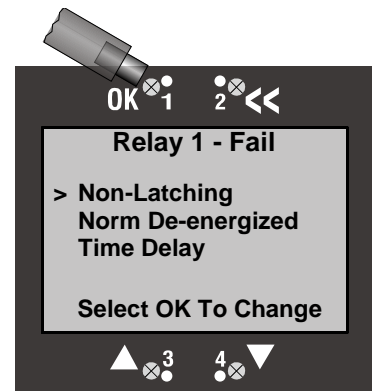

5.2.8.2.4 Relay 2

Relay 2 can be set as latching or non-latching and normally energized or normally de-energized. The activation time delay for the relay can also be adjusted. See Section 4.4

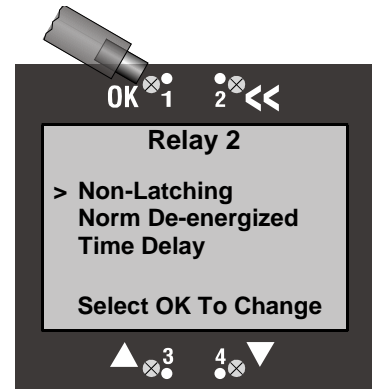

5.2.8.2.5 Relay 3

Relay 3 can be set as latching or non-latching and normally energized or normally de-energized. The activation time delay for the relay can also be adjusted. See Section 4.4

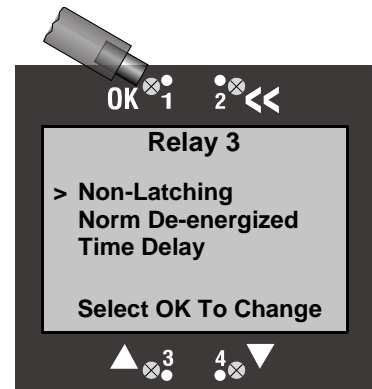

5.2.8.2.6 Relay 4

Relay 4 can be set as latching or non-latching and normally energized or normally de-energized. The activation time delay for the relay can also be adjusted. See Section 4.4

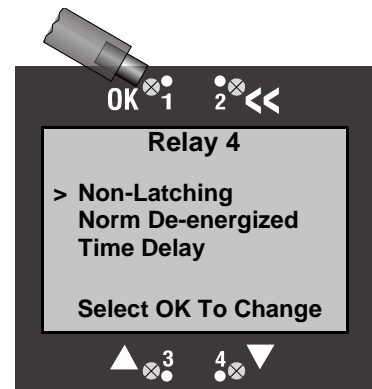

5.2.8.2.7 Warn Current-Relay 5

The Warn Current-Relay 5 is a warning function that drops the 4-20 mA output to the Fault Current Level when an assigned condition occurs. The relay will accept the four alarms as assigned conditions. The Low Current Time Adjust is used to change the amount of time the Warn Current-Relay 5 remains at the Fault Current level when a warning occurs. See Section 4.3

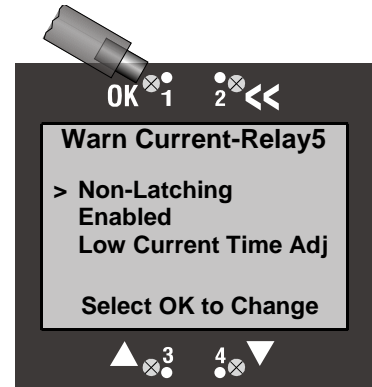

5.2.8.2.8 Relay 6 (Horn)

The 95dB Piezo horn is located on the bottom right side of the enclosure. The sounder can be activated by any alarm and warning condition. The alarm reset conforms to ISA alarm sequence 3A by using the red pushbutton switch. The horn has a timeout feature controlled by Timeout Enabled/Disabled and Timeout Delay. See Section 4.5.

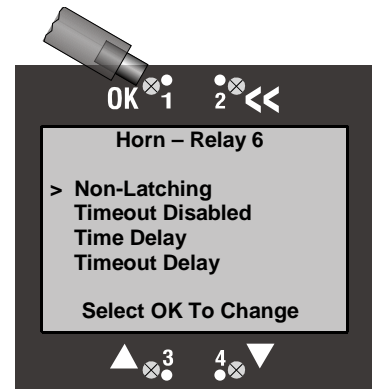

5.2.8.2.9 Relay 7 (Red Strobe)

The Red Strobe Relay 7 can be set as latching or non-latching and normally energized or normally de-energized. The activation time delay for the relay can also be adjusted. See Section 4.6.

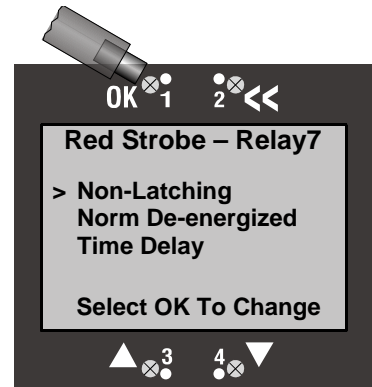

5.2.8.2.10 Relay 8 (Amber Strobe)

The optional Amber Strobe Relay 8 can be set as latching or non-latching and normally energized or normally de-energized. The activation time delay for the relay can also be adjusted. See Section 4.6.

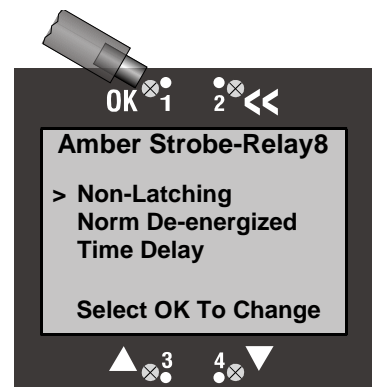

5.2.8.3 4/20 mA Adjustment

The 4/20mA adjustment menu provides the capability of adjusting the 4mA, 20mA, and 1mA fault output current using the ▼ and ▲ control arrows. To use this feature you must have a current monitor (or equivalent device) connected to the Monitor and the 4/20mA output loop active.

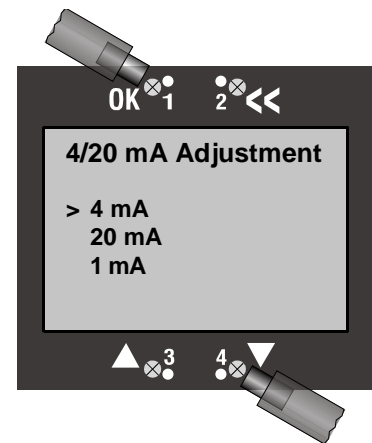

5.2.8.4 Adjust Date/Time

Allows the system clock and date format to be set. The two available date formats are “DD/MM/YY” and “MM/DD/YY.” When setting or adjusting the date & time, screens are presented in the following sequence: Month, Date, Year, Hour, Minute. **Note:** The month and date screens are reversed when the “DD/MM/YY” format is selected. The system clock is always in a 24 hour format.

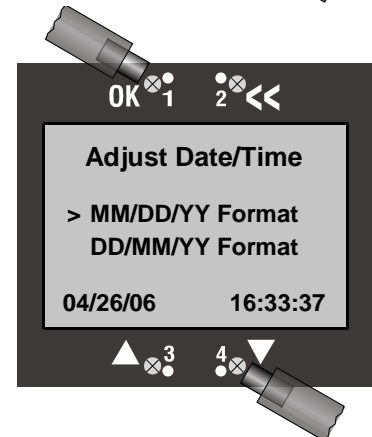

5.2.8.5 Communication Setup

This menu provides adjustment for both standard and optional installed communications methods. Options installed will be displayed. If there are no optional communications installed, this screen will indicate “No Comm Installed”.

Possible options are:

- Hart Comm
- Modbus Comm

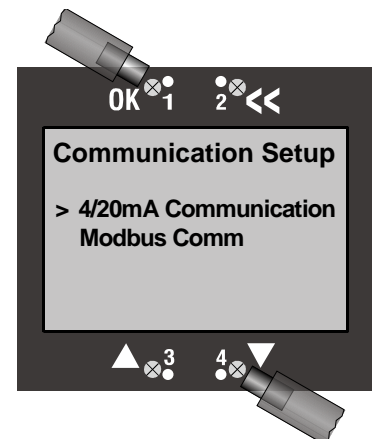

5.2.8.5.1 4-20mA Communications

The 4-20 mA Communications menu allows the unit to send the SensAlert identification and configuration message “SensAlert Sensor ID”. It is used to allow the Monitor to identify itself to SensAlert controllers. If you do not have a SensAlert controller installed select “None” from the menu.

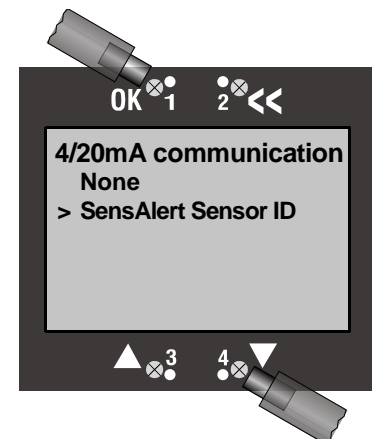

5.2.8.5.2 No Comm Installed

If an optional communication board is not installed.

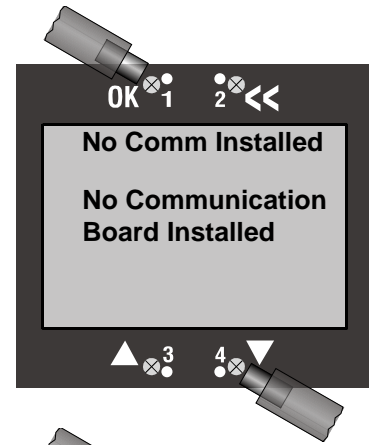

5.2.8.5.3 HART Comm

No user adjustments available through this interface.

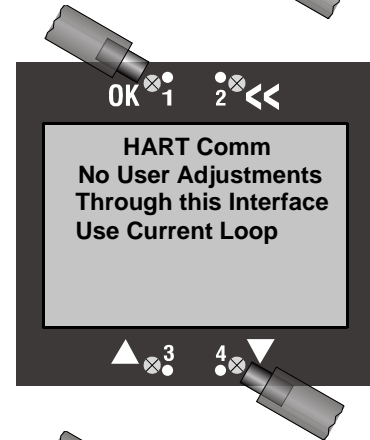

5.2.8.5.4 Modbus Comm

The optional Modbus communication board allows the Monitor to communicate on a Modbus RS485 2 or 4 wire network. User parameters that can be modified are:

- Modbus Address 001 – 255
- Baud Rate 9600, 19200, or 38400
- Parity None, Odd, or Even
- Stop Bits 1 or 2

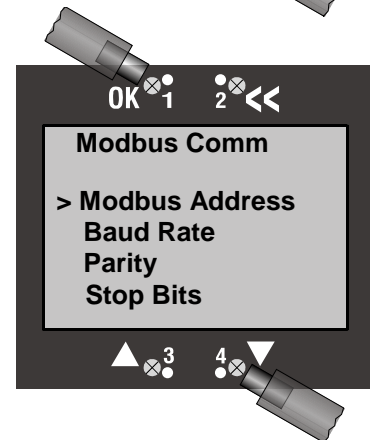

5.2.8.6 ToD Mode Adjustment

The ToD Mode Adjustment menu allows you to enable and disable the automatic testing mode, set the date & time for testing, set the number of days between tests, set the cell intensity, and designate output & fault indicators. Step-by-step instructions on using the functions in this menu are described in Section 3.3.

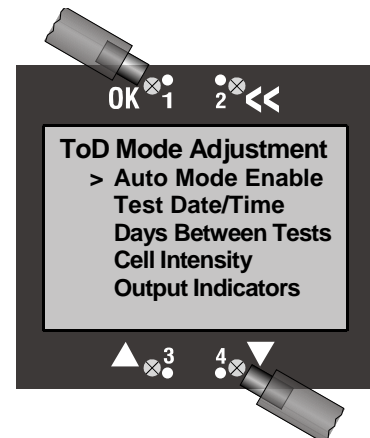

5.2.8.7 Sensor Adjustment

Refer to Section 3.2 for more information.

Sensor Adjustment includes two functions: Selecting the calibration gas and selecting the K Factor. A K Factor is used when the target gas is different from the calibration gas (Methane or Propane). Different K Factors are used depending on whether a Catalytic Bead Combustible or Infrared Combustible sensor is installed, and whether Methane or Propane is the calibration gas.

Use this interface to Set Sensor Adjustment configuration settings on Infrared and Catalytic Bead combustible Sensors.

5.2.8.7.1 No Adjustments Are Possible

If Toxic or Oxygen sensor installed,
No Adjustments Are Possible

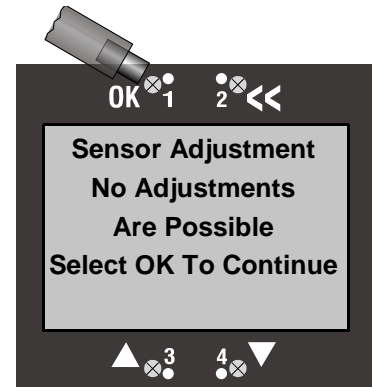

5.2.8.7.2 Sensor Adjustment

Selections available if a Catalytic Bead or Infrared Combustible Sensor is installed:

Select Cal Gas – Methane, Propane, or Other. Changing calibration gas on an IR sensor will cause a Monitor reset to install different coefficients for the sensor.

Select K-Factor – A selection of None will set the K-Factor to 1.00. A Custom K-Factor will allow an adjustable K-Factor to entered.

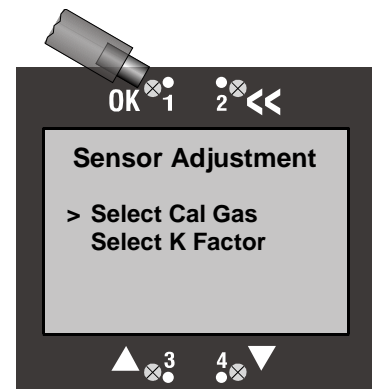

5.2.8.8 Set Password

The Monitor comes from the factory without a password. When a password is set the System Configuration menu cannot be accessed without first entering the password. Other menu items in the Main Menu are still accessible without a password.

To set a new password, select “System Configuration” from the Main menu. Within the Systems Configuration menu select “Set Password.” The screen at right will appear. To set a new password use the ▲ and ▼ arrow keys to enter a number between 0 and 9. Select OK to set the number and move to the next character.



Note

All passwords must be 6 characters long and consist only of the numbers 0 through 9.

A second screen will appear showing the number you have just entered, followed by a “0” and “XXXX.” Use the ▲ and ▼ arrows to enter a number. Select OK to set the number and move to the next character.



Continue doing this until you reach the last digit. The screen will look like the one on the right. When you have entered the last digit of the new password select OK to set the new password.



A screen will appear asking you to confirm your new password. Select OK to save your new password.

Note

To change a password repeat the above steps by entering six different digits. To disable/delete your password repeat the above steps but enter “000000” as your new password,



Note

If you lose your password go to “Lost Password” in the Main Menu and select OK. A screen will appear (right) giving you a number to call and a code number. Give the code number that appears on your Monitor screen to the appropriate service person to reset your password.

Note

The code at right is a sample code. The real code will change every time you change your password.

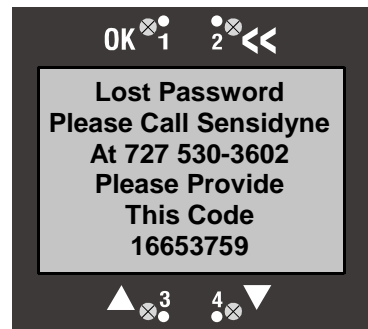

5.2.8.9 Reset Defaults

This will restore the Monitor to the Factory Default Values. The Monitor restarts if OK is selected.

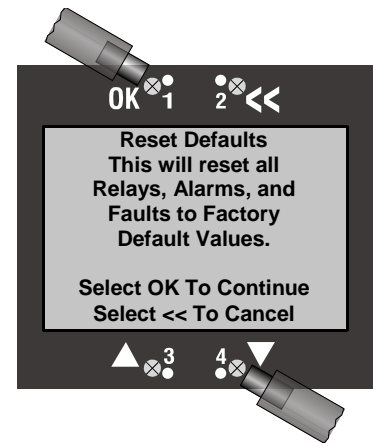

5.2.8.10 Set Monitor Tag

The Monitor Tag is the text that appears at the top of the display on the Main Display, Missing Sensor Display, and Sensor Warm up Display. The Tag can hold up to 21 symbols. The symbols consist of upper case letters, numbers, math symbols, and some punctuation symbols.

The inverse character indicates the current selected location. Use the ▲ and ▼ arrow keys to scroll through the potential Symbols until you reach the desired symbol. Select **OK** to select the present symbol and advance to the Next location. Select << to go to a previous location. If the Selected location is at the left edge of the display selecting << one more time will cancel any changes to the Tag line. Selecting **OK** when the selected location is at the right edge of the display will advance to the next screen.

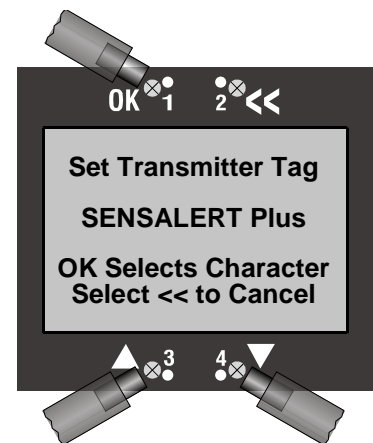

Selecting **OK** will save the displayed Tag Line.
 Selecting << will cancel the operation and retain the previous Tag Line.

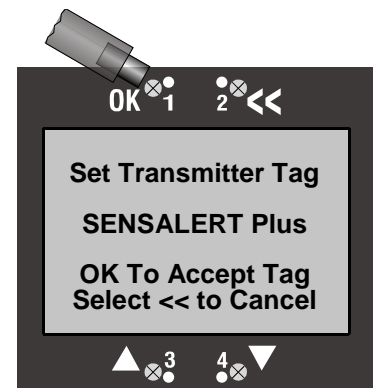

6 Product Numbers & Parts List

6.1 Monitors

Product Number	Description
----------------	-------------

NO STROBE

820-0302-01 NO STROBE
820-0302-02 NO STROBE WITH BATTERIES

SINGLE STROBE

820-0301-01 RED STROBE
820-0301-02 RED STROBE WITH BATTERIES
820-0303-01 BLUE STROBE
820-0303-02 BLUE STROBE WITH BATTERIES
820-0304-01 AMBER STROBE
820-0304-02 AMBER STROBE WITH BATTERIES

DUAL STROBE

820-0301-03 AMBER & RED STROBE
820-0301-04 AMBER & RED STROBE WITH BATTERIES
820-0305-01 AMBER & BLUE STROBE
820-0305-02 AMBER & BLUE STROBE WITH BATTERIES

6.2 Sensors

For a complete list of available sensors and ranges contact the factory.

6.3 Options & Accessories

Product Number	Description
----------------	-------------

821-0204-02	Test-on-Demand™ (Type C)
821-0204-06	Test-on-Demand™ (Type S)
821-0206-01	Test-on-Demand™ Cell Gasket
821-0301-01	Remote Kit
821-0302-02	HART Communication Board Field Install Kit - SensAlarm Plus
821-0303-02	Modbus RS485 Communication Board Field Install Kit - SensAlarm Plus
821-0203-01	Rainshield
7013154-1	Aspirator, encased (Brass)
7013154-2	Aspirator, encased (Stainless Steel)
7013227-3	SensAlert Four Channel Controller
7013227-4	SensAlert Four Channel Controller with Strobe

6.4 Spare Parts

Product Number	Description
----------------	-------------

821-0214-01	Sensor Shield
821-0215-01	Sensor Gasket
821-0217-01	Sensor Holder O-Ring
7017461	Rigid / IMC Conduit Grounding Hub
7013201-1	Magnetic Screwdriver (with reversible screwdriver blade)
360-0126-01	SensAlarm Plus User Manual
209-0032-01	Fuses 5x20mm 2 Amps slow blow 250V
206-0016-01	Battery SLA 12V 1.4 AH

6.5 Calibration Equipment

Product Number	Description
009827-1	Regulator (1 LPM), for use with all gases
7016929	Regulator (1 LPM), for use with NH ₃ , Cl ₂ , HCl, SO ₂ , NO ₂
7010032-1	PVC Carrying Case (holds two gas cylinders, plus regulator, tubing & fitting)
7013885	Humidification Kit (Recommended for setting acid gas zero) for use with Cl ₂ , HCl, HF, NO ₂ , and SO ₂
821-0223-01	Calibration Plug
7016042	Tygon® Tubing, 3/16" ID x 5/16", sold per foot
7015551	Teflon® Tubing, 1/4" OD, sold per foot

6.6 Zero Calibration Gases

Product Number	Description
009824-15	Zero Gas for Oxygen (O ₂) or Infrared sensors, 100% Nitrogen (103L)
009824-25	Zero Gas for all other sensors including Infrared, 20.9% O ₂ in N ₂ (103L)

6.7 Calibration Gases¹

All calibration gases are in Aluminum or Steel cylinders containing either 58 SL or 103 SL of gas. PPM gas has an eight (8) month shelf life and all other gases have a one (1) year shelf life. Select span gas level to prove alarm settings are functioning. Gas is shipped with a Material Safety Data Sheet (MSDS). A NIST traceable calibration certificate is available upon request.

Product Number	Description
009824-68	Acetylene [C ₂ H ₂], 1.25 %vol in Air
009824-57	Ammonia [NH ₃], 25 ppm in Nitrogen (58L)
009824-38	Ammonia [NH ₃], 50 ppm in Nitrogen (58L)
009824-67	Ammonia [NH ₃], 300 ppm in Nitrogen (58L)
009824-5	Carbon Dioxide [CO ₂], 5000 ppm in Air (103L)
009824-62	Carbon Dioxide [CO ₂], 1.5 %vol in Nitrogen (103L)
009824-4	Carbon Monoxide [CO], 50 ppm in Nitrogen (103L)
009824-65	Carbon Monoxide [CO], 100 ppm in Nitrogen (103L)
009824-18	Carbon Monoxide [CO], 250 ppm in Nitrogen (103L)
009824-53	Chlorine ³ [Cl ₂], 2 ppm in Nitrogen (58L)
009824-34	Chlorine ³ [Cl ₂], 5 ppm in Nitrogen (58L)
009824-44	Chlorine ³ [Cl ₂], 10 ppm in Nitrogen (58L)
009824-41	Chlorine ³ [Cl ₂], 50 ppm in Nitrogen (58L)

Chlorine Dioxide [ClO₂], (Zero gas & calibrated gas generator) ⁴
Some customers use Chlorine as a functional check gas. ²

¹ **Recommended practice for determining calibration frequency.** Sensidyne equipment is tested and calibrated prior to shipment. After installation and stabilization of the gas Monitor, qualified personnel should verify calibration by applying zero and span gases. This procedure should be performed at commissioning, then repeated 30 and 60 days afterwards, with deviations in zero and span recorded. The calibration or functional check interval can then be adjusted to suit that application's conditions. For further information, please consult the ISA Recommended Practices for gas detectors.

² The use of functional check or surrogate gases do not represent actual calibration of the sensor with the target gas, and should not be employed as such, unless the user has established a known, repeatable correlation with the target gas.

³ The humidification kit is recommended for setting the sensor zero, ONLY for acid gases.

⁴ Requires participation In Sensidyne's "Sensor Exchange Program" regarding these gases. Please contact factory for further information.

6.7 Calibration Gases¹ (continued)

009824-60	Diborane [B ₂ H ₆], (Zero & Span gases) ⁴ Ethylene Oxide [C ₂ H ₄ O], 5 ppm in Nitrogen (58L) Fluorine [F ₂], (Permeation Tube) ⁴
009824-6	Germane [GeH ₄], (Zero & Span gases, Permeation Tube) ⁴
009824-16	Hydrogen [H ₂], 2 %vol / 50 %LEL in Air (103L) Hydrogen [H ₂], (ppm) Electrochemical, 500 ppm in Air (103L)
009824-56	Hydrogen Chloride ³ [HCl], 5 ppm in Nitrogen (58L)
009824-37	Hydrogen Chloride ³ [HCl], 10 ppm HCl in Nitrogen (58L)
009824-41	Hydrogen Chloride ³ [HCl], 50 ppm HCl in Nitrogen (58L)
009824-54	Hydrogen Cyanide ³ [HCN], 10 ppm in Nitrogen (58L) Hydrogen Fluoride [HF], (Permeation Tube) ⁴
009824-55	Hydrogen Sulfide ³ [H ₂ S], 5 ppm in Nitrogen (58L)
009824-9	Hydrogen Sulfide ³ [H ₂ S], 10 ppm in Nitrogen (58L)
009824-33	Hydrogen Sulfide ³ [H ₂ S], 25 ppm in Nitrogen (58L)
009824-10	Hydrogen Sulfide ³ [H ₂ S], 50 ppm in Nitrogen (58L)
009824-2	Methane [CH ₄], 1.5 %vol / 30 %LEL in Air (103L)
009824-3	Methane [CH ₄], 2.5 %vol / 50 %LEL in Air (103L)
009824-35	Nitric Oxide [NO], 30 ppm in Nitrogen (58L)
009824-43	Nitrogen Dioxide ³ [NO ₂], 5 ppm in Nitrogen (103L)
009824-36	Nitrogen Dioxide ³ [NO ₂], 10 ppm in Nitrogen (103L)
009824-63	Oxygen [O ₂], 10 %vol in Nitrogen (103L)
009824-64	Oxygen [O ₂], 18.5 %vol in Nitrogen (103L)
009824-13	Oxygen [O ₂], 20 %vol in Nitrogen (103L)
009824-25	Oxygen [O ₂], 20.9 %vol in Nitrogen (103L) Ozone [O ₃], (Zero gas & calibrated gas generator) ⁴ Phosgene [COCl ₂], (Permeation Tube) ⁴
009824-1	Propane [C ₃ H ₈], 0.66 %vol / 30 %LEL in Air (103L)
009824-61	Propane [C ₃ H ₈], 0.95 %vol / 50 %LEL in Air (103L)
009824-58	Phosphine [PH ₃], 0.5 ppm in Nitrogen (58L)
009824-59	Silane [SiH ₄], 5 ppm in Nitrogen (58L)
009824-8	Sulfur Dioxide [SO ₂], 5 ppm in Nitrogen (58L)
009824-39	Sulfur Dioxide [SO ₂], 10 ppm in Nitrogen (58L)
009824-17	Sulfur Dioxide [SO ₂], 50 ppm in Nitrogen (58L)

¹ **Recommended practice for determining calibration frequency.** Sensidyne equipment is tested and calibrated prior to shipment. After installation and stabilization of the gas Monitor, qualified personnel should verify calibration by applying zero and span gases. This procedure should be performed at commissioning, then repeated 30 and 60 days afterwards, with deviations in zero and span recorded. The calibration or functional check interval can then be adjusted to suit that application's conditions. For further information, please consult the ISA Recommended Practices for gas detectors.

² The use of functional check or surrogate gases do not represent actual calibration of the sensor with the target gas, and should not be employed as such, unless the user has established a known, repeatable correlation with the target gas.

³ The humidification kit is recommended for setting the sensor zero, ONLY for acid gases.

⁴ Requires participation in Sensidyne's "Sensor Exchange Program" regarding these gases. Please contact factory for further information.

7 Appendix A: Declaration of Conformity

Sensidyne, LP
DECLARATION OF CONFORMITY
Certificate: SENSALARM PLUS MONITOR

Issue 2 September 30, 2014

The undersigned declares that the products named in this certificate meet the provisions of the European Communities Council Directives and Standards referenced on this document.

Product Type: SensAlarm Plus

Part Number(s): 820-030X-XX SensAlarm Plus

Manufacturer: Sensidyne, LP
1000 112th Circle North
Suite 100
St. Petersburg, Florida 33716
U.S.A.

Intended Use: Gas Detection

Conforming to the following standards:
EMC Directive 2004/108/EC

Emissions and Immunity

EN55022 Group 1 Class A 2006/A2:2007
ICES-003 Class A
FCC Part 15 per ANSI C63.4:2003 Class A
EN 61326-1: 2006 EMC General Requirements
IEC 61000-4-2:1995/EN 61000-4-2:1995/A1:1998/A2; 2001 Electrostatic Discharge Immunity Test
IEC 61000-4-3:2006/EN 61000-4-3:2006 Electromagnetic Field Immunity Test
IEC 61000-4-4:2004/EN 61000-4-4:2004 Electrical Fast Transient/Burst Immunity Test
IEC 61000-4-5:2005/ EN 61000-4-5:2006 Surge Immunity Test
IEC 61000-4-6:2003/A1:2004/A2:2006/EN 61000-4-6:2007 Immunity to Conducted Disturbances
IEC 61000-4-8:1993/EN 61000-4-8:1994/A1:2001 Power Frequency Magnetic Field Immunity Test
IEC 61000-4-11:2004/EN 61000-4-11:2004 Voltage dips, short interruptions, voltage variations
Immunity Test

Product Safety Low Voltage Directive 2006/05/EC

EN 61010-1-2001
UL 61010-1 2005
CAN/CSA C22.2 No.61010-1-2004

Signed: 

Date: 

Name: Bob Madeiros
Title: Quality Assurance and Regulatory Affairs Manager Sensidyne, LP

Who is the natural and legal person with responsibility for the design, manufacture, packaging and labelling before the device is placed on the market under his own name, regardless of whether these operations are carried out by the Manufacturer or on his behalf by a third party.

SensAlarm Plus

8 Appendix B: Specifications

General Specifications

Sampling SystemDiffusion
 Non-Intrusive Magnetic Controls.....**OK, << (Go Back), ▲ , ▼**

Monitor with Non-Metallic Enclosure

Mounting Requirement.....Wall mounted to stud, unistrut, or plate with supplied feet
 Dimensions.....9.75" (W) x 20.0" (H) x 6.4" (D)
 248 mm (W) x 508 mm (H) x 163 mm (D)
 with optional rain shield height 21.5" (546mm)
 Weight Range.....9.75-13.75 lbs / 4.4-6.3 kg

Electrical/Electronic Specifications

Power Input Requirements.....20-30 VDC and or 100-240 VAC, 50/60 Hz
 Current ConsumptionDC 2.0 A maximum with relays and strobes energized
 AC 1.5 A maximum
 Output.....4-20 mA into 600 ohms
 User-selectable output current during calibration; ability to test
 current loop and adjust output current at the 4 mA and 20 mA
 extremes, and Fault Output Current
 Relays.....240V, 3A, 50/60 Hz
 6A, 120V
 6A, 24VDC Resistive
 Check points.....Enable reading of output current as 40–200 mV.
 Transmission Link4–20 mA current, non-isolated 2 wires, sourcing
 Optional: Modbus RS-485, 2 or 4 wires and HART
 FusesReplacement by service personnel only
 2 Amp 5x20mm slow blow 250V
 BatteriesSealed lead acid 12V 1.4 AH

Environmental

Temperature Range-4°F to 122°F / -20°C to 50°C
 Humidity Range 0-90 %RH, non-condensing
 Above ratings are subject to sensor limitations.

Ingress ProtectionNEMA 4X or 3R, IPX4 with battery option

Approvals: (Refer to Appendices A and D for full ratings)

9 Appendix C: Troubleshooting Guide

<i>Symptom</i>	<i>Remedy</i>
Unusual operation at installation of power	
<i>Display irregularities upon initial power application.</i>	Reset system by removing power, waiting 15 seconds and reapplying power. Normal startup should be observed.
No Display	
<i>No power supplied to Monitor</i>	Measure AC voltage at TB1 power distribution board. Measure DC voltage at TB2 power distribution board.
<i>Open fuse</i>	Check fuses 1-4 on power distribution board.
Cannot derive 40 mV at check points, but display shows zero	
<i>Wiring at TB1 of the main board is defective.</i>	Check and correct wiring.
<i>Zero control out of electronics module is defective.</i>	Zero the Monitor. If unsuccessful replace electronics.
After “Zero OK”, display shows a slightly positive value instead of zero	
<i>Presence of target gas.</i>	Normal operation.
After “Zero Failed” 2nd time, display shows a slightly positive value	
<i>Presence of target gas</i>	Normal operation.
<i>A biased sensor (Ammonia or Hydrogen Chloride) has not yet stabilized.</i>	Biased sensors typically take longer to stabilize than non-biased sensors, especially if the bias sensor has become de-stabilized. A destabilized biased sensor may take up to 72 hours to re-stabilize.
<i>Incorrect battery board used for biased sensor.</i>	Check to ensure proper battery bias board is used.
<i>Sensor is damaged or defective.</i>	Replace suspect sensor with a backup sensor known to be good. Repeat start-up procedure. If display shows slightly positive value, gas is present. If display shows zero, suspect sensor is bad.
Screen shows that span calibration has failed.	
<i>Calibration gas concentration is incorrect.</i>	Verify calibration gas concentration with a detector tube and assure proper delivery of calibration gas to sensor assembly.
<i>Sensor is defective.</i>	Replace sensor assembly.
<i>Sensor Interface Assembly is defective.</i>	Replace Sensor Interface Assembly.
Monitor shows “Missing Sensor” on display.	
<i>Sensor assembly is loose or missing.</i>	Make certain sensor assembly is properly installed. This can be tested by removing and reinserting the sensor. Make certain sensor head unit is properly connected to the power supply board.
<i>Sensor board or interface is defective.</i>	Contact Sensidyne for RMA.

Monitor remains with “APPLY GAS NOW” on display.

Calibration gas is present. Verify gas is correct type for sensor calibration.

Sensor or Monitor is defective. Apply gas in normal operation. If no response, sensor is defective. If response shown, Monitor is defective.

Monitor displays garbled characters.

Sensor assembly not correctly installed. Remove sensor, wait 10 seconds, and then reinstall sensor in sensor holder.

No gas concentration reading displayed on controller.

“SensAlert Sensor ID” has not be selected in communications setup. Go to System Configuration/Communication Setup/4-20 mA Communication and select “SensAlert Sensor ID.”

Relay(s) assigned to alarm condition(s) do not activate.

Relays not assigned. Verify that relay(s) desired for each alarm condition have, in fact, been assigned. Go to System Configuration/Alarm Settings/Alarm Functions/Alarms 1, 2, 3, and/or TWA. “Relays assigned _____” will be displayed. Use the Add Relay function to assign the relay(s) for that alarm.

Time delay is not set as desired for each relay. Go to System Configuration/Alarm Settings/Alarm Functions/Relays 1, 2, 3, 4, and/or Warn current-Relay5 and set the desired time delay for each relay.

Alarm is disabled. Go to System Configuration/Alarm Settings/Alarm Functions/Alarms 1, 2, 3, and/or TWA and enable the alarm(s).

Alarm is incorrectly set as ascending or descending. Go to System Configuration/Alarm Settings/Alarm Functions/Alarms 1, 2, 3, and/or TWA and correctly set the alarm(s) as ascending or descending.

Alarm setpoint has been incorrectly set. Go to System Configuration/Alarm Settings/Alarm Functions/Alarms 1, 2, 3, and/or TWA and correctly set the alarm setpoint(s).

10 Appendix D: TUV Certification

ZERTIFIKAT • CERTIFICATE • 認証証書 • CERTIFICADO • CERTIFICAT



CERTIFICATE

No. U8 10 04 71335 001

Holder of Certificate: Sensidyne, LP
SENSIDYNE

Production Facility(ies): 71335

Certification Mark:



Product: Measuring instruments for gas or vapor
 Universal Gas Monitor

Model(s): SensAlarm Plus

Parameters:

Rated Input Voltage:	100-240V~ or 20-30VDC
Rated Frequency:	50/60 Hz or N/A
Rated Input Power:	1.5 A or 2.0 A
Environmental Rating:	50°C Ambient
Protection Class:	I
Degree of Protection:	IPX4

Tested according to: CAN/CSA C22.2 No. 61010-1-2004
 UL 61010-1:2005
 EN 61010-1:2001

The product was voluntarily tested according to the relevant safety requirements and mentioned properties. It can be marked with the certification mark shown above. The certification mark must not be altered in any way. See also notes overleaf.

Test report no.: 090-905775-000

Date, 2010-05-05

Page 1 of 1



TÜV SÜD AMERICA INC • 10 Centennial Drive • Peabody, MA 01960 USA • www.TUVamerica.com

TUV®

11 Appendix F: Returned Material Authorization

Sensidyne maintains an instrument service facility at the factory to provide its customers with both warranty and non-warranty repair. Sensidyne assumes no liability for service performed by personnel other than authorized Sensidyne authorized personnel. To facilitate the repair process, please contact the Sensidyne Service Department in advance for assistance with a problem which cannot be remedied and/or requires the return of the product to the factory. All returned products require a Returned Material Authorization (RMA) number. Sensidyne Service Department personnel may be reached at:

Sensidyne, LP
1000 112th Circle N, Suite 100
St. Petersburg, FL 33716 USA
800-451-9444 • +1 727-530-3602
+1 727-538-0671 [Service Fax] email: info@sensidyne.com

All non-warranty repair orders will have a minimum fee assessed whether the repair is authorized or not. This fee includes handling, administration and technical expenses for inspecting the instrument and providing an estimate. However, the estimate fee is waived if the repair is authorized.

If you wish to set a limit to the authorized repair cost, state a “not to exceed” figure on your purchase order. Please indicate if a price quotation is required before authorization of the repair cost, understanding that this invokes extra cost and handling delay. Sensidyne’s repair policy is to perform all needed repairs to restore the instrument to its full operating condition.

Repairs are handled on a “first in - first out” basis. Your order may be expedited if you authorize an expediting fee. This will place your order next in line behind orders currently in process.

Pack the instrument and its accessories (preferably in their original packing) and enclose your return address, purchase order, shipping and billing information, RMA number, a description of the problem encountered with your instrument and any special instructions. All prices are subject to change without notice.

If this is the first time you are dealing directly with the factory, you will be asked to prepay or to authorize a COD shipment.

Send the instrument, prepaid, to:

SENSIDYNE
1000 112th CIRCLE N, SUITE 100
ST. PETERSBURG, FL 33716 USA
ATTENTION: Service Department
RMA #: _____

SERVICE OPTIONS

The Sensidyne Service Department offers a variety of service options which will minimize costly interruptions and maintenance costs. These options include initial training, on-site technical assistance, and full factory repairs. Sensidyne has developed several programs which offer options best suited to your applications and needs. For further information, contact the Sensidyne Service Department at the following numbers: 800-451-9444 • +1 727-530-3602 • +1 727-538-0671 [Service Fax].

12 Appendix G: Configuration Reference

Password is: 000000 • Monitor P/N _____ • Monitor S/N _____

Sensor (Gas) ** (Conc.) ** (P/N) _____ ToD Cell P/N _____

Calibration Gas Concentration ** ppm %LEL %vol

Communication Setup: 4-20 mA Communication None SensAlert Sensor ID

**Boxes with
"X" indicate
default setting**

ToD Mode Adjustment (** = Value depends on type of installed sensor)

Auto Mode Enable: Disabled Enabled • Days Between Tests ** • Cell Intensity ** %

Output Indicators: None 4-20 Current Loop

Alarm Settings – Alarm Functions (** = Value depends on type of installed sensor)

Relays Assigned	Alarm 1	Alarm 2	Alarm 3	TWA Alarm
1 – Fail	<input type="checkbox"/>	<input type="checkbox"/>	<input type="checkbox"/>	<input type="checkbox"/>
2	<input type="checkbox"/>	<input type="checkbox"/>	<input type="checkbox"/>	<input type="checkbox"/>
3	<input type="checkbox"/>	<input type="checkbox"/>	<input type="checkbox"/>	<input type="checkbox"/>
4	<input type="checkbox"/>	<input type="checkbox"/>	<input type="checkbox"/>	<input type="checkbox"/>
5 – Warn Current	<input type="checkbox"/>	<input type="checkbox"/>	<input type="checkbox"/>	<input type="checkbox"/>
6 – Horn	<input type="checkbox"/>	<input type="checkbox"/>	<input type="checkbox"/>	<input type="checkbox"/>
7 – Red Strobe	<input type="checkbox"/>	<input type="checkbox"/>	<input type="checkbox"/>	<input type="checkbox"/>
8 – Amber Strobe	<input type="checkbox"/>	<input type="checkbox"/>	<input type="checkbox"/>	<input type="checkbox"/>
Enabled	<input type="checkbox"/>	<input type="checkbox"/>	<input type="checkbox"/>	<input type="checkbox"/>
Disabled	<input checked="" type="checkbox"/>	<input checked="" type="checkbox"/>	<input checked="" type="checkbox"/>	<input checked="" type="checkbox"/>
Ascending **	<input type="checkbox"/>	<input type="checkbox"/>	<input type="checkbox"/>	<input type="checkbox"/>
Descending **	<input type="checkbox"/>	<input type="checkbox"/>	<input type="checkbox"/>	<input type="checkbox"/>
Setpoint **	_____	_____	_____	_____
Release Offset **	_____	_____	_____	_____
Average Time Adjust for TWA Alarm	<input type="checkbox"/> 15m	<input type="checkbox"/> 30m	<input type="checkbox"/> 60m	<input type="checkbox"/> 2h
	<input type="checkbox"/> 4h	<input checked="" type="checkbox"/> 8h		

Alarm Settings – Fault Functions (** = Value depends on type of installed sensor)

Relays Assigned	Head Fail	Missing Sensor	Sensor Fail	Sensor End Of Life	Output Current Track	Cal Mode	Maint. Mode	ToD Fail	ToD End Of Life
1 – Fail	<input checked="" type="checkbox"/>	<input checked="" type="checkbox"/>	<input checked="" type="checkbox"/>	<input type="checkbox"/>	<input type="checkbox"/>	<input type="checkbox"/>	<input type="checkbox"/>	<input type="checkbox"/>	<input type="checkbox"/>
2	<input type="checkbox"/>	<input type="checkbox"/>	<input type="checkbox"/>	<input type="checkbox"/>	<input type="checkbox"/>	<input type="checkbox"/>	<input type="checkbox"/>	<input type="checkbox"/>	<input type="checkbox"/>
3	<input type="checkbox"/>	<input type="checkbox"/>	<input type="checkbox"/>	<input type="checkbox"/>	<input type="checkbox"/>	<input type="checkbox"/>	<input type="checkbox"/>	<input type="checkbox"/>	<input type="checkbox"/>
4	<input type="checkbox"/>	<input type="checkbox"/>	<input type="checkbox"/>	<input type="checkbox"/>	<input type="checkbox"/>	<input type="checkbox"/>	<input type="checkbox"/>	<input type="checkbox"/>	<input type="checkbox"/>
6 – Horn	<input type="checkbox"/>	<input type="checkbox"/>	<input type="checkbox"/>	<input type="checkbox"/>	<input type="checkbox"/>	<input type="checkbox"/>	<input type="checkbox"/>	<input type="checkbox"/>	<input type="checkbox"/>
7 – Red Strobe	<input type="checkbox"/>	<input type="checkbox"/>	<input type="checkbox"/>	<input type="checkbox"/>	<input type="checkbox"/>	<input type="checkbox"/>	<input type="checkbox"/>	<input type="checkbox"/>	<input type="checkbox"/>
8 – Amber Strobe	<input type="checkbox"/>	<input type="checkbox"/>	<input type="checkbox"/>	<input type="checkbox"/>	<input type="checkbox"/>	<input type="checkbox"/>	<input type="checkbox"/>	<input type="checkbox"/>	<input type="checkbox"/>
Enabled	<input checked="" type="checkbox"/>	<input checked="" type="checkbox"/>	<input checked="" type="checkbox"/>	<input type="checkbox"/>	<input type="checkbox"/>	<input type="checkbox"/>	<input type="checkbox"/>	<input type="checkbox"/>	<input type="checkbox"/>
Disabled	<input type="checkbox"/>	<input type="checkbox"/>	<input type="checkbox"/>	<input checked="" type="checkbox"/>	<input checked="" type="checkbox"/>	<input checked="" type="checkbox"/>	<input checked="" type="checkbox"/>	<input checked="" type="checkbox"/>	<input checked="" type="checkbox"/>
Fault Current	3.0mA	3.0mA	3.0mA	3.0mA	3.0mA	3.0mA	3.0mA	3.0mA	3.0mA
Current Delay	NA	NA	NA	10	10	NA	NA	10	10

Alarm Settings – Relay Status Functions

Relay Status	Relay 1 - Fail	Relay 2	Relay 3	Relay 4	Relay 5	Relay 6	Relay 7	Relay 8	Horn	Red Strobe	Amber Strobe
Norm Energized	<input checked="" type="checkbox"/>	<input type="checkbox"/>	<input type="checkbox"/>	<input type="checkbox"/>	<input type="checkbox"/>	<input type="checkbox"/>	<input type="checkbox"/>	<input type="checkbox"/>	<input type="checkbox"/>	<input type="checkbox"/>	<input type="checkbox"/>
Norm De-energized	<input type="checkbox"/>	<input checked="" type="checkbox"/>	<input checked="" type="checkbox"/>	<input checked="" type="checkbox"/>	<input checked="" type="checkbox"/>	<input checked="" type="checkbox"/>	<input checked="" type="checkbox"/>	<input checked="" type="checkbox"/>	<input checked="" type="checkbox"/>	<input checked="" type="checkbox"/>	<input checked="" type="checkbox"/>
Latching	<input type="checkbox"/>	<input type="checkbox"/>	<input type="checkbox"/>	<input type="checkbox"/>	<input type="checkbox"/>	<input type="checkbox"/>	<input type="checkbox"/>	<input type="checkbox"/>	<input type="checkbox"/>	<input type="checkbox"/>	<input type="checkbox"/>
Non-Latching	<input checked="" type="checkbox"/>	<input checked="" type="checkbox"/>	<input checked="" type="checkbox"/>	<input checked="" type="checkbox"/>	<input checked="" type="checkbox"/>	<input checked="" type="checkbox"/>	<input checked="" type="checkbox"/>	<input checked="" type="checkbox"/>	<input checked="" type="checkbox"/>	<input checked="" type="checkbox"/>	<input checked="" type="checkbox"/>
Time Delay(in secs)	10	10	10	10	10	10	10	10	30	10	10
Timeout Enabled										<input type="checkbox"/>	
Timeout Disabled										<input checked="" type="checkbox"/>	
Timeout Delay										240	

Select CMB Cal Gas ** Methane Propane Other _____

Select K Factor ** (CB = Catalytic Bead, IR = Infrared)

	CB-Methane	CB-Propane	CB-Other	IR-Methane	IR-Propane	IR-Other
None	<input type="checkbox"/>	<input type="checkbox"/>	<input type="checkbox"/>	<input type="checkbox"/>	<input type="checkbox"/>	<input type="checkbox"/>
Hydrogen	<input type="checkbox"/>	<input type="checkbox"/>	<input type="checkbox"/>	<input type="checkbox"/>	<input type="checkbox"/>	<input type="checkbox"/>
Propane	<input type="checkbox"/>	<input type="checkbox"/>	<input type="checkbox"/>	<input type="checkbox"/>	<input type="checkbox"/>	<input type="checkbox"/>
Hexane	<input type="checkbox"/>	<input type="checkbox"/>	<input type="checkbox"/>	<input type="checkbox"/>	<input type="checkbox"/>	<input type="checkbox"/>
Butane	<input type="checkbox"/>	<input type="checkbox"/>	<input type="checkbox"/>	<input type="checkbox"/>	<input type="checkbox"/>	<input type="checkbox"/>
Methanol	<input type="checkbox"/>	<input type="checkbox"/>	<input type="checkbox"/>	<input type="checkbox"/>	<input type="checkbox"/>	<input type="checkbox"/>
Butadiene	<input type="checkbox"/>	<input type="checkbox"/>	<input type="checkbox"/>	<input type="checkbox"/>	<input type="checkbox"/>	<input type="checkbox"/>
Custom K Factor is:	_____	_____	_____	_____	_____	_____

THIS PAGE INTENTIONALLY LEFT BLANK

SensAlarm Plus CONFIGURATION REFERENCE

Password is: _____ • Monitor P/N _____ • Monitor S/N _____

Sensor (Gas) _____ (Conc.) _____ (P/N) _____ ToD Cell P/N _____

Calibration Gas Concentration _____ ppm %LEL %vol

Communication Setup: 4/20 mA Communication None SensAlert Sensor ID

ToD Mode Adjustment

Auto Mode Enable: Disabled Enabled • Days Between Tests _____ • Cell Intensity _____%

Output Indicators: None 4-20 Current Loop

Alarm Settings – Alarm Functions

Relays Assigned	Alarm 1	Alarm 2	Alarm 3	TWA Alarm
1 – Fail	<input type="checkbox"/>	<input type="checkbox"/>	<input type="checkbox"/>	<input type="checkbox"/>
2	<input type="checkbox"/>	<input type="checkbox"/>	<input type="checkbox"/>	<input type="checkbox"/>
3	<input type="checkbox"/>	<input type="checkbox"/>	<input type="checkbox"/>	<input type="checkbox"/>
4	<input type="checkbox"/>	<input type="checkbox"/>	<input type="checkbox"/>	<input type="checkbox"/>
5 – Warn Current	<input type="checkbox"/>	<input type="checkbox"/>	<input type="checkbox"/>	<input type="checkbox"/>
6 - Horn	<input type="checkbox"/>	<input type="checkbox"/>	<input type="checkbox"/>	<input type="checkbox"/>
7 – Red Strobe	<input type="checkbox"/>	<input type="checkbox"/>	<input type="checkbox"/>	<input type="checkbox"/>
8 – Amber Strobe	<input type="checkbox"/>	<input type="checkbox"/>	<input type="checkbox"/>	<input type="checkbox"/>
Enabled	<input type="checkbox"/>	<input type="checkbox"/>	<input type="checkbox"/>	<input type="checkbox"/>
Disabled	<input type="checkbox"/>	<input type="checkbox"/>	<input type="checkbox"/>	<input type="checkbox"/>
Ascending	<input type="checkbox"/>	<input type="checkbox"/>	<input type="checkbox"/>	<input type="checkbox"/>
Descending	<input type="checkbox"/>	<input type="checkbox"/>	<input type="checkbox"/>	<input type="checkbox"/>
Setpoint	_____	_____	_____	_____
Release Offset	_____	_____	_____	_____
Average Time Adjust for TWA Alarm	<input type="checkbox"/> 15m	<input type="checkbox"/> 30m	<input type="checkbox"/> 60m	<input type="checkbox"/> 2h
	<input type="checkbox"/> 4h	<input type="checkbox"/> 8h		

Alarm Settings – Fault Functions

Relays Assigned	Head Fail	Missing Sensor	Sensor Fail	Sensor End Of Life	Output Current Track	Cal Mode	Maint. Mode	ToD Fail	ToD End Of Life
1 - Fail	<input type="checkbox"/>	<input type="checkbox"/>	<input type="checkbox"/>	<input type="checkbox"/>	<input type="checkbox"/>	<input type="checkbox"/>	<input type="checkbox"/>	<input type="checkbox"/>	<input type="checkbox"/>
2	<input type="checkbox"/>	<input type="checkbox"/>	<input type="checkbox"/>	<input type="checkbox"/>	<input type="checkbox"/>	<input type="checkbox"/>	<input type="checkbox"/>	<input type="checkbox"/>	<input type="checkbox"/>
3	<input type="checkbox"/>	<input type="checkbox"/>	<input type="checkbox"/>	<input type="checkbox"/>	<input type="checkbox"/>	<input type="checkbox"/>	<input type="checkbox"/>	<input type="checkbox"/>	<input type="checkbox"/>
4	<input type="checkbox"/>	<input type="checkbox"/>	<input type="checkbox"/>	<input type="checkbox"/>	<input type="checkbox"/>	<input type="checkbox"/>	<input type="checkbox"/>	<input type="checkbox"/>	<input type="checkbox"/>
6 - Horn	<input type="checkbox"/>	<input type="checkbox"/>	<input type="checkbox"/>	<input type="checkbox"/>	<input type="checkbox"/>	<input type="checkbox"/>	<input type="checkbox"/>	<input type="checkbox"/>	<input type="checkbox"/>
7 – Red Strobe	<input type="checkbox"/>	<input type="checkbox"/>	<input type="checkbox"/>	<input type="checkbox"/>	<input type="checkbox"/>	<input type="checkbox"/>	<input type="checkbox"/>	<input type="checkbox"/>	<input type="checkbox"/>
8 – Amber Strobe	<input type="checkbox"/>	<input type="checkbox"/>	<input type="checkbox"/>	<input type="checkbox"/>	<input type="checkbox"/>	<input type="checkbox"/>	<input type="checkbox"/>	<input type="checkbox"/>	<input type="checkbox"/>
Enabled	<input type="checkbox"/>	<input type="checkbox"/>	<input type="checkbox"/>	<input type="checkbox"/>	<input type="checkbox"/>	<input type="checkbox"/>	<input type="checkbox"/>	<input type="checkbox"/>	<input type="checkbox"/>
Disabled	<input type="checkbox"/>	<input type="checkbox"/>	<input type="checkbox"/>	<input type="checkbox"/>	<input type="checkbox"/>	<input type="checkbox"/>	<input type="checkbox"/>	<input type="checkbox"/>	<input type="checkbox"/>
Fault Current	NA	NA	NA	_____	_____	NA	NA	_____	_____
Current Delay	NA	NA	NA	_____	_____	NA	NA	_____	_____

Alarm Settings – Relay Status Functions

Relay Status	Relay 1 - Fail	Relay 2	Relay 3	Relay 4	Relay 5	Relay 6	Relay 7	Relay 8	Horn	Red Strobe	Amber Strobe
Norm Energized	<input type="checkbox"/>	<input type="checkbox"/>	<input type="checkbox"/>	<input type="checkbox"/>	<input type="checkbox"/>	<input type="checkbox"/>	<input type="checkbox"/>	<input type="checkbox"/>	<input type="checkbox"/>	<input type="checkbox"/>	<input type="checkbox"/>
Norm De-energized	<input type="checkbox"/>	<input type="checkbox"/>	<input type="checkbox"/>	<input type="checkbox"/>	<input type="checkbox"/>	<input type="checkbox"/>	<input type="checkbox"/>	<input type="checkbox"/>	<input type="checkbox"/>	<input type="checkbox"/>	<input type="checkbox"/>
Latching	<input type="checkbox"/>	<input type="checkbox"/>	<input type="checkbox"/>	<input type="checkbox"/>	<input type="checkbox"/>	<input type="checkbox"/>	<input type="checkbox"/>	<input type="checkbox"/>	<input type="checkbox"/>	<input type="checkbox"/>	<input type="checkbox"/>
Non-Latching	<input type="checkbox"/>	<input type="checkbox"/>	<input type="checkbox"/>	<input type="checkbox"/>	<input type="checkbox"/>	<input type="checkbox"/>	<input type="checkbox"/>	<input type="checkbox"/>	<input type="checkbox"/>	<input type="checkbox"/>	<input type="checkbox"/>
Time Delay(in secs)	_____	_____	_____	_____	_____	_____	_____	_____	_____	_____	_____
Timeout Enabled	<input type="checkbox"/>	<input type="checkbox"/>	<input type="checkbox"/>	<input type="checkbox"/>	<input type="checkbox"/>	<input type="checkbox"/>	<input type="checkbox"/>	<input type="checkbox"/>	<input type="checkbox"/>	<input type="checkbox"/>	<input type="checkbox"/>
Timeout Disabled	<input type="checkbox"/>	<input type="checkbox"/>	<input type="checkbox"/>	<input type="checkbox"/>	<input type="checkbox"/>	<input type="checkbox"/>	<input type="checkbox"/>	<input type="checkbox"/>	<input type="checkbox"/>	<input type="checkbox"/>	<input type="checkbox"/>
Timeout Delay	_____	_____	_____	_____	_____	_____	_____	_____	_____	_____	_____

Select CMB Cal Gas Methane Propane Other _____

Select K Factor (CB = Catalytic Bead, IR = Infrared)

CB-Methane	CB-Propane	CB-Other	IR-Methane	IR-Propane	IR-Other
None	<input type="checkbox"/>	<input type="checkbox"/>	<input type="checkbox"/>	<input type="checkbox"/>	<input type="checkbox"/>
Hydrogen	<input type="checkbox"/>	<input type="checkbox"/>	<input type="checkbox"/>	<input type="checkbox"/>	<input type="checkbox"/>
Propane	<input type="checkbox"/>	<input type="checkbox"/>	<input type="checkbox"/>	<input type="checkbox"/>	<input type="checkbox"/>
Hexane	<input type="checkbox"/>	<input type="checkbox"/>	<input type="checkbox"/>	<input type="checkbox"/>	<input type="checkbox"/>
Butane	<input type="checkbox"/>	<input type="checkbox"/>	<input type="checkbox"/>	<input type="checkbox"/>	<input type="checkbox"/>
Methanol	<input type="checkbox"/>	<input type="checkbox"/>	<input type="checkbox"/>	<input type="checkbox"/>	<input type="checkbox"/>
Butadiene	<input type="checkbox"/>	<input type="checkbox"/>	<input type="checkbox"/>	<input type="checkbox"/>	<input type="checkbox"/>
Custom K Factor is:	_____	_____	_____	_____	_____

THIS PAGE INTENTIONALLY LEFT BLANK

SensAlarm Plus CONFIGURATION REFERENCE

Password is: _____ • Monitor P/N _____ • Monitor S/N _____
 Sensor (Gas) _____ (Conc.) _____ (P/N) _____ ToD Cell P/N _____
 Calibration Gas Concentration _____ ppm %LEL %vol
 Communication Setup: 4/20 mA Communication None SensAlert Sensor ID

ToD Mode Adjustment

Auto Mode Enable: Disabled Enabled • Days Between Tests _____ • Cell Intensity _____%
 Output Indicators: None 4-20 Current Loop

Alarm Settings – Alarm Functions

Relays Assigned	Alarm 1	Alarm 2	Alarm 3	TWA Alarm
1 – Fail	<input type="checkbox"/>	<input type="checkbox"/>	<input type="checkbox"/>	<input type="checkbox"/>
2	<input type="checkbox"/>	<input type="checkbox"/>	<input type="checkbox"/>	<input type="checkbox"/>
3	<input type="checkbox"/>	<input type="checkbox"/>	<input type="checkbox"/>	<input type="checkbox"/>
4	<input type="checkbox"/>	<input type="checkbox"/>	<input type="checkbox"/>	<input type="checkbox"/>
5 – Warn Current	<input type="checkbox"/>	<input type="checkbox"/>	<input type="checkbox"/>	<input type="checkbox"/>
6 - Horn	<input type="checkbox"/>	<input type="checkbox"/>	<input type="checkbox"/>	<input type="checkbox"/>
7 – Red Strobe	<input type="checkbox"/>	<input type="checkbox"/>	<input type="checkbox"/>	<input type="checkbox"/>
8 – Amber Strobe	<input type="checkbox"/>	<input type="checkbox"/>	<input type="checkbox"/>	<input type="checkbox"/>
Enabled	<input type="checkbox"/>	<input type="checkbox"/>	<input type="checkbox"/>	<input type="checkbox"/>
Disabled	<input type="checkbox"/>	<input type="checkbox"/>	<input type="checkbox"/>	<input type="checkbox"/>
Ascending	<input type="checkbox"/>	<input type="checkbox"/>	<input type="checkbox"/>	<input type="checkbox"/>
Descending	<input type="checkbox"/>	<input type="checkbox"/>	<input type="checkbox"/>	<input type="checkbox"/>
Setpoint	_____	_____	_____	_____
Release Offset	_____	_____	_____	_____
Average Time Adjust for TWA Alarm	<input type="checkbox"/> 15m	<input type="checkbox"/> 30m	<input type="checkbox"/> 60m <input type="checkbox"/> 2h	<input type="checkbox"/> 4h <input type="checkbox"/> 8h

Alarm Settings – Fault Functions

Relays Assigned	Head Fail	Missing Sensor	Sensor Fail	Sensor End Of Life	Output Current Track	Cal Mode	Maint. Mode	ToD Fail	ToD End Of Life
1 - Fail	<input type="checkbox"/>	<input type="checkbox"/>	<input type="checkbox"/>	<input type="checkbox"/>	<input type="checkbox"/>	<input type="checkbox"/>	<input type="checkbox"/>	<input type="checkbox"/>	<input type="checkbox"/>
2	<input type="checkbox"/>	<input type="checkbox"/>	<input type="checkbox"/>	<input type="checkbox"/>	<input type="checkbox"/>	<input type="checkbox"/>	<input type="checkbox"/>	<input type="checkbox"/>	<input type="checkbox"/>
3	<input type="checkbox"/>	<input type="checkbox"/>	<input type="checkbox"/>	<input type="checkbox"/>	<input type="checkbox"/>	<input type="checkbox"/>	<input type="checkbox"/>	<input type="checkbox"/>	<input type="checkbox"/>
4	<input type="checkbox"/>	<input type="checkbox"/>	<input type="checkbox"/>	<input type="checkbox"/>	<input type="checkbox"/>	<input type="checkbox"/>	<input type="checkbox"/>	<input type="checkbox"/>	<input type="checkbox"/>
6 - Horn	<input type="checkbox"/>	<input type="checkbox"/>	<input type="checkbox"/>	<input type="checkbox"/>	<input type="checkbox"/>	<input type="checkbox"/>	<input type="checkbox"/>	<input type="checkbox"/>	<input type="checkbox"/>
7 – Red Strobe	<input type="checkbox"/>	<input type="checkbox"/>	<input type="checkbox"/>	<input type="checkbox"/>	<input type="checkbox"/>	<input type="checkbox"/>	<input type="checkbox"/>	<input type="checkbox"/>	<input type="checkbox"/>
8 – Amber Strobe	<input type="checkbox"/>	<input type="checkbox"/>	<input type="checkbox"/>	<input type="checkbox"/>	<input type="checkbox"/>	<input type="checkbox"/>	<input type="checkbox"/>	<input type="checkbox"/>	<input type="checkbox"/>
Enabled	<input type="checkbox"/>	<input type="checkbox"/>	<input type="checkbox"/>	<input type="checkbox"/>	<input type="checkbox"/>	<input type="checkbox"/>	<input type="checkbox"/>	<input type="checkbox"/>	<input type="checkbox"/>
Disabled	<input type="checkbox"/>	<input type="checkbox"/>	<input type="checkbox"/>	<input type="checkbox"/>	<input type="checkbox"/>	<input type="checkbox"/>	<input type="checkbox"/>	<input type="checkbox"/>	<input type="checkbox"/>
Fault Current	_____	_____	_____	_____	_____	_____	_____	_____	_____
Current Delay	NA	NA	NA	_____	_____	NA	NA	_____	_____

Alarm Settings – Relay Status Functions

Relay Status	Relay 1 - Fail	Relay 2	Relay 3	Relay 4	Relay 5	Relay 6	Relay 7	Relay 8
Norm Energized	<input type="checkbox"/>	<input type="checkbox"/>	<input type="checkbox"/>	<input type="checkbox"/>	<input type="checkbox"/>	<input type="checkbox"/>	<input type="checkbox"/>	<input type="checkbox"/>
Norm De-energized	<input type="checkbox"/>	<input type="checkbox"/>	<input type="checkbox"/>	<input type="checkbox"/>	<input type="checkbox"/>	<input type="checkbox"/>	<input type="checkbox"/>	<input type="checkbox"/>
Latching	<input type="checkbox"/>	<input type="checkbox"/>	<input type="checkbox"/>	<input type="checkbox"/>	<input type="checkbox"/>	<input type="checkbox"/>	<input type="checkbox"/>	<input type="checkbox"/>
Non-Latching	<input type="checkbox"/>	<input type="checkbox"/>	<input type="checkbox"/>	<input type="checkbox"/>	<input type="checkbox"/>	<input type="checkbox"/>	<input type="checkbox"/>	<input type="checkbox"/>
Time Delay(in secs)	_____	_____	_____	_____	_____	_____	_____	_____
Timeout Enabled	<input type="checkbox"/>	<input type="checkbox"/>	<input type="checkbox"/>	<input type="checkbox"/>	<input type="checkbox"/>	<input type="checkbox"/>	<input type="checkbox"/>	<input type="checkbox"/>
Timeout Disabled	<input type="checkbox"/>	<input type="checkbox"/>	<input type="checkbox"/>	<input type="checkbox"/>	<input type="checkbox"/>	<input type="checkbox"/>	<input type="checkbox"/>	<input type="checkbox"/>
Timeout Delay	_____	_____	_____	_____	_____	_____	_____	_____

Select CMB Cal Gas Methane Propane Other _____

Select K Factor (CB = Catalytic Bead, IR = Infrared)

CB-Methane	CB-Propane	CB-Other	IR-Methane	IR-Propane	IR-Other
None	<input type="checkbox"/>	<input type="checkbox"/>	<input type="checkbox"/>	<input type="checkbox"/>	<input type="checkbox"/>
Hydrogen	<input type="checkbox"/>	<input type="checkbox"/>	<input type="checkbox"/>	<input type="checkbox"/>	<input type="checkbox"/>
Propane	<input type="checkbox"/>	<input type="checkbox"/>	<input type="checkbox"/>	<input type="checkbox"/>	<input type="checkbox"/>
Hexane	<input type="checkbox"/>	<input type="checkbox"/>	<input type="checkbox"/>	<input type="checkbox"/>	<input type="checkbox"/>
Butane	<input type="checkbox"/>	<input type="checkbox"/>	<input type="checkbox"/>	<input type="checkbox"/>	<input type="checkbox"/>
Methanol	<input type="checkbox"/>	<input type="checkbox"/>	<input type="checkbox"/>	<input type="checkbox"/>	<input type="checkbox"/>
Butadiene	<input type="checkbox"/>	<input type="checkbox"/>	<input type="checkbox"/>	<input type="checkbox"/>	<input type="checkbox"/>
Custom K Factor is:	_____	_____	_____	_____	_____

THIS PAGE INTENTIONALLY LEFT BLANK

13 Appendix H: Mounting Drawings

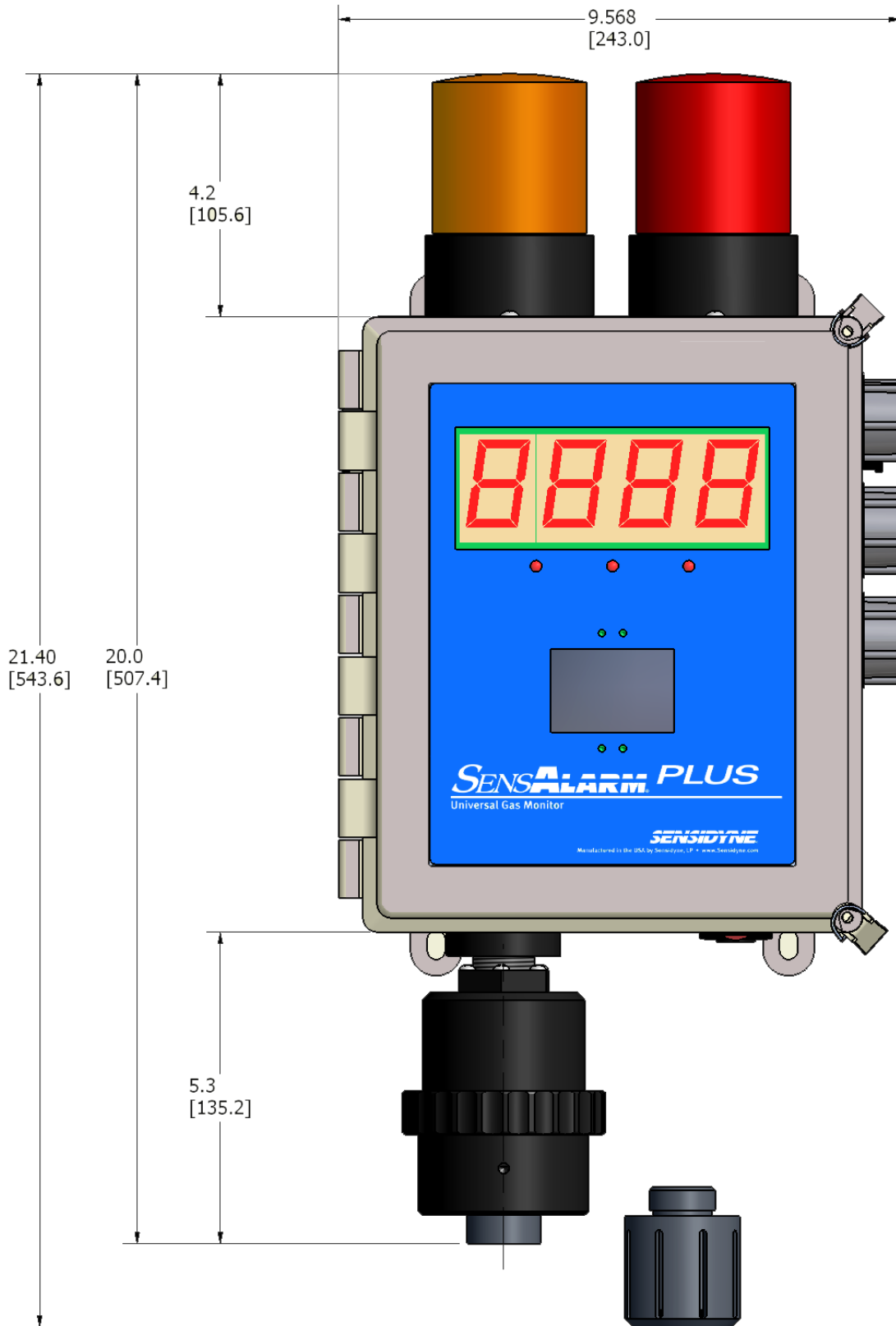

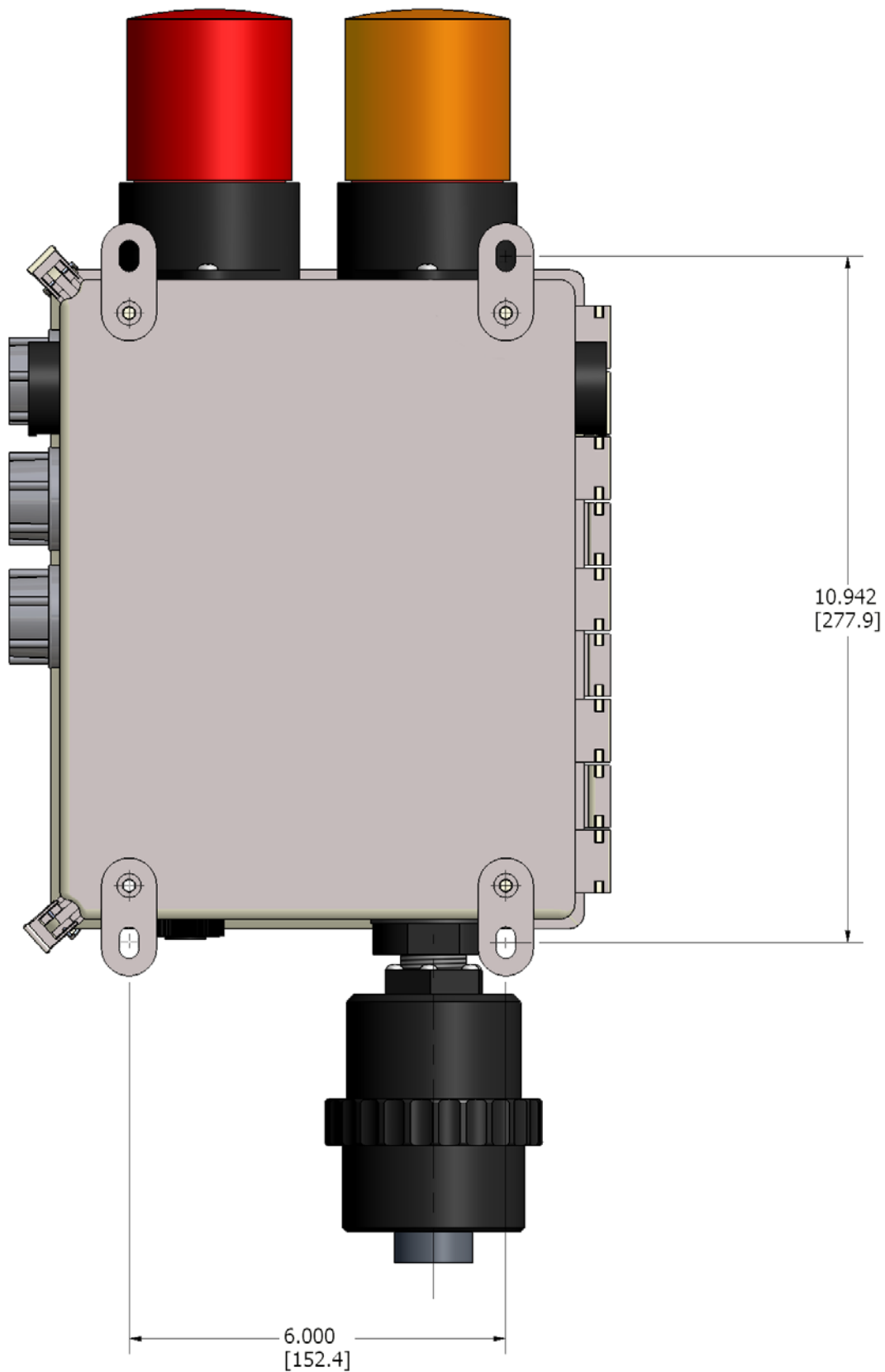

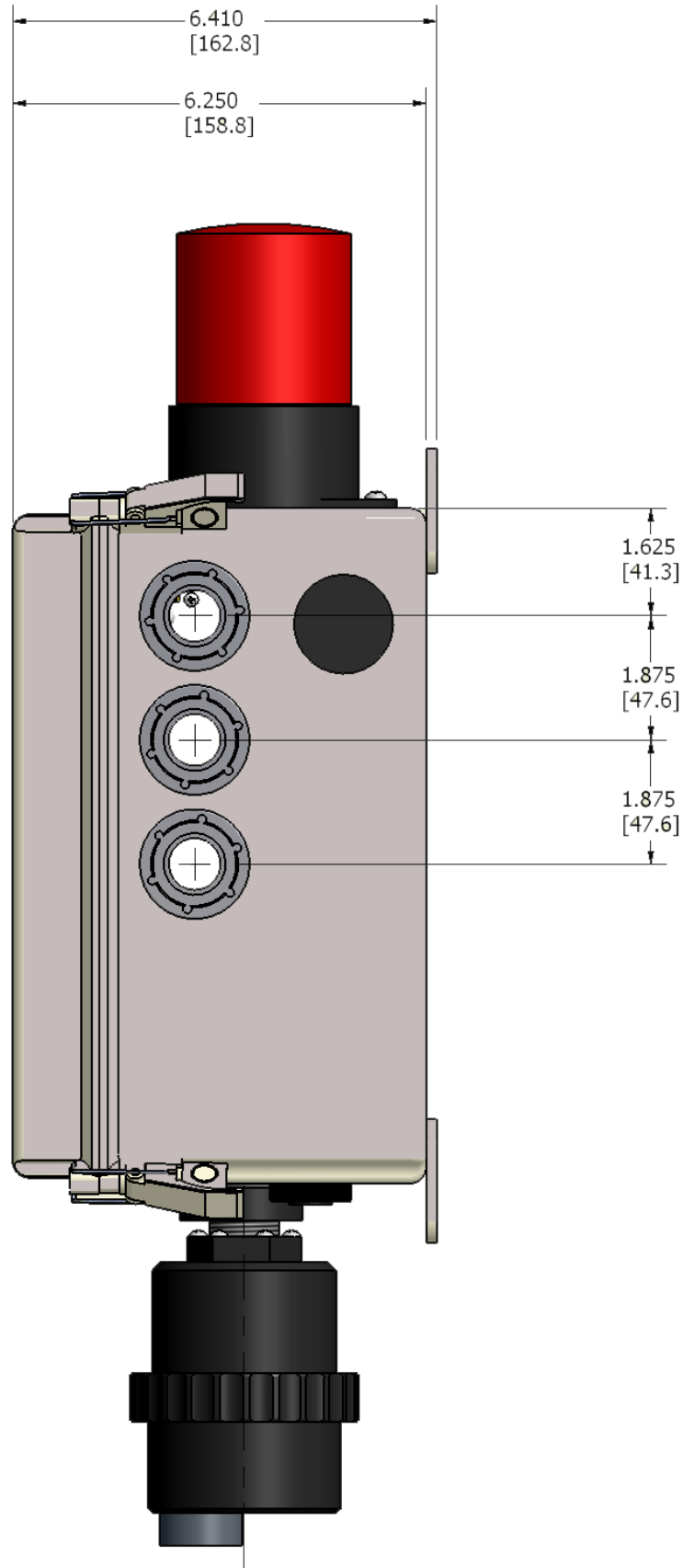

Mounting Dimensions: Monitor With Fiberglass Enclosure

THIS PAGE INTENTIONALLY LEFT BLANK

THIS PAGE INTENTIONALLY LEFT BLANK

Manufactured by:

Sensidyne, LP
1000 112th Circle N, Suite 100
St. Petersburg, Florida 33716
USA

800-451-9444 • 727-530-3602 • 727-539-0550 [fax]
www.Sensidyne.com • info@Sensidyne.com

Authorized EU Representative

Schauenburg Electronic Technologies GmbH
Weseler Str. 35 · 45478
Mülheim-Ruhr Germany

+49 (0) 208 9 99 10 • +49 (0) 208 5 41 10 [fax]
www.schauenburg.com • international@schauenburg.com

SENSIDYNE[®]

Sensidyne, LP
1000 112th Circle N, Suite 100
St. Petersburg, Florida 33716 USA
800-451-9444 • +1 727-530-3602 • +1 727-539-0550 [fax]
web: www.sensidyne.com • e-mail: info@sensidyne.com